

MODIS-M 25W

Recessed Can Light

The MODIS series is a modular lighting series with an exquisite design and UGR19 anti-glare feature. It supports six installation methods, including recessed, canopy ceiling, surface-mounted, pendant, and track options. With four size choices (Ø55mm, Ø65mm, Ø85mm, Ø100mm), it uses a Bridgelux COB light source, achieving 120lm/W efficiency. It offers interchangeable CCT and wattage (except Ø55mm), multiple reflector angles, and flicker-free drivers. Ideal for commercial and residential spaces, such as hotels, offices, museums, and homes.



SPECIFICATIONS

Material Specifications

Material	Aluminium & Transparent Tempered Glass
Mounting	Recessed
Colour	Black RAL9005/ White RAL9016
Dimensions	85mm (Dia) x 274mm (H)
Cutout	89mm
Ingress Protection	IP20
Warranty	5 Year Replacement

Electrical Specifications

Power Supply	Integral Driver, 500mA, Phase Dimmable
Connection Method	Terminal Block in base
Input Voltage	240V

Optic Specifications

Light Source	Tridonic 25W LED
Delivered Lumens	2150-3200lm
CRI	Ra >90
Colour Deviation	SDCM ≤ 5
Reported L70 (Hours)	50,000 Hrs

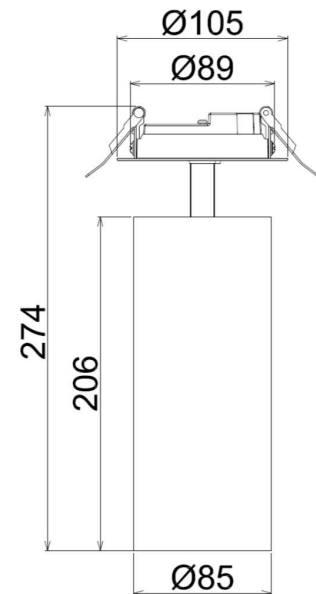

VARIATIONS

LC1477B	MODIS-M 25W Recessed Can Light, Black, 36°, Phase Dim, Tri-Colour, 2150-3200lm
LC1477W	MODIS-M 25W Recessed Can Light, White, 36°, Phase Dim, Tri-Colour, 2150-3200lm