

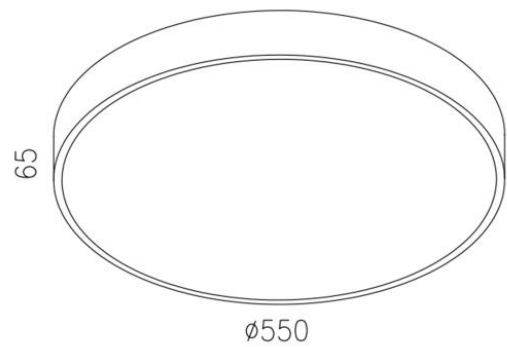

Product Overview

Product Name / Code	MILAN 55W Round Ceiling Light - LC4526
Description	White, 550mm, 4000K, Phase-Dim
Manufacturer	Decrolux Lighting Pty Ltd



Laboratory and Equipment

System Name / Model	LabSpion / Freedom VIS (Custom Viso)
Manufacturer / Serial Number	Ibsen Photonics, Denmark / 2417457569
Sensor Name	LabSensor Model2
Sensor Serial Number / Calibration Date	3430823524 / 7/12/2022

Measurement Details

Test Date and Time	12/07/2023 6:52:29 PM
Operator	Johnny Elmer
C-Planes Measured	36
Measurement Resolution	10°
Measurement Distance	453.1cm
Measurement Number	VFR-230712-0118-MS
Tracking Link	http://www.visosystems.com/tracking/?id=VT230713-003566



Performance

Total Lumen Output	5975lm
Light Efficiency	105 Lumen/Watt
Peak (cd)	1991cd
Nominal Power	57.1W
Input Voltage	240V
Frequency of Input Power	60Hz
Power Factor	0.98
Warm-up (stabilisation) Time	Lamp stabilized in 1 hour 11 min
Warm-up Variation	-3.8%

Spectral Power Distribution (SPD)

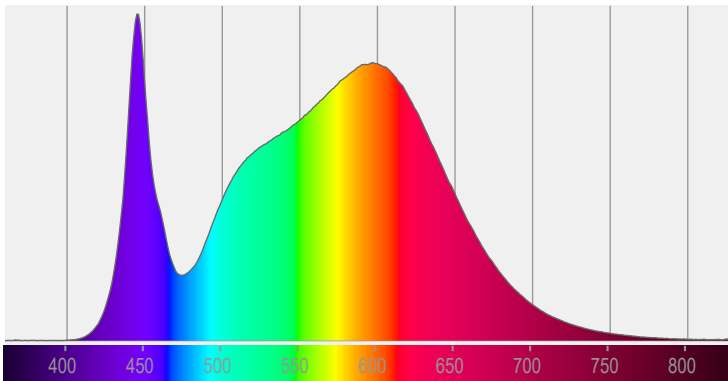

Input Power Curve

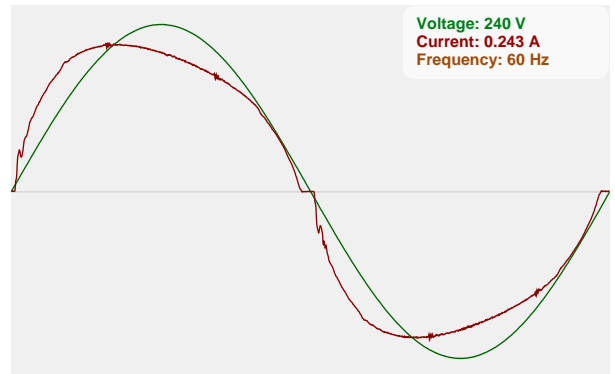

Optic Specifications

Correlated Colour Temperature, Target	4000K
Correlated Colour Temperature, Measured	3963K
Colour Rendering Index	CRI 83.4
R9 Value	R9 = 11.9
Colour Rendering TM30-18	R _f 84.3 - R _g 98.3
Colour Quality Scale	CQS = 83.0
Beam Angle	117.1°

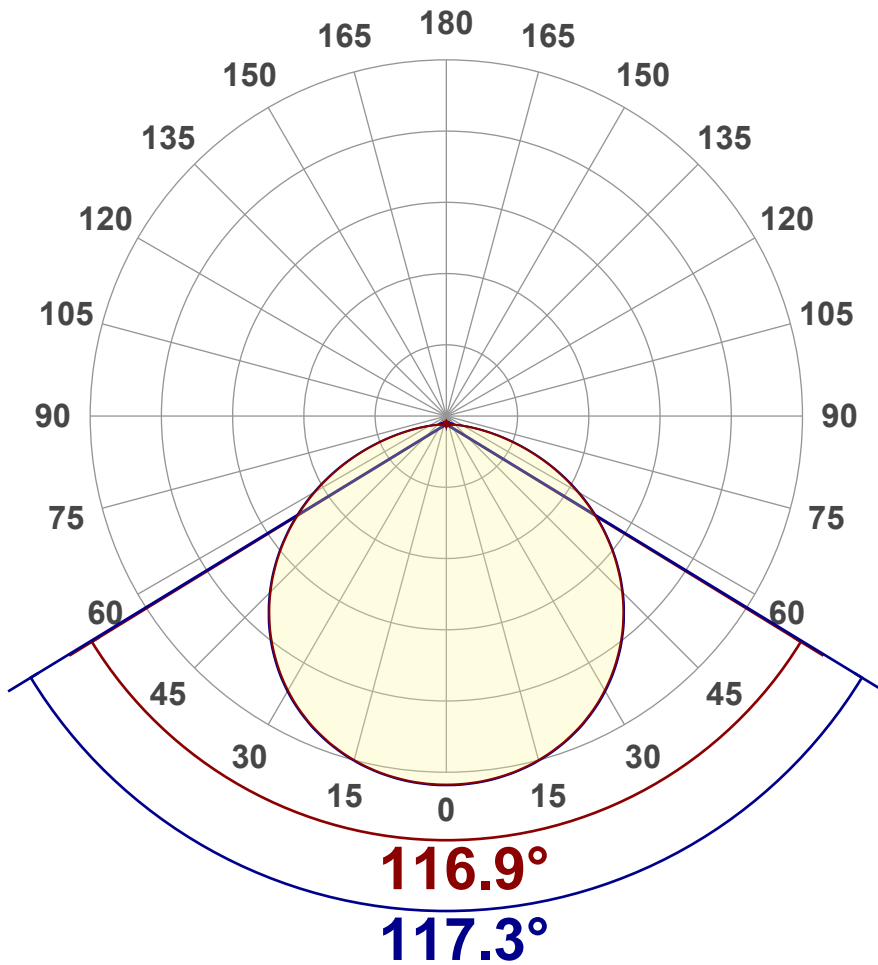

Angular Distribution – 0° / 90° Plane

Main Values

Total Lumen Output	5975 lm
Lumen Up% / Down%	0.13 % / 99.87%
Peak Intensity	1991 cd
Beam Angle (50%)	117.1°
Beam Angle (90%)	117.3°
Beam Angle (10%)	117°

Cut-off Angle

Average 2.5%	173.8°
---------------------	--------

Field Angle

Average 10%	162.1°
--------------------	--------

Intensity Ratio

In 120° Cone	78.3%
In 90° Cone	52.7%

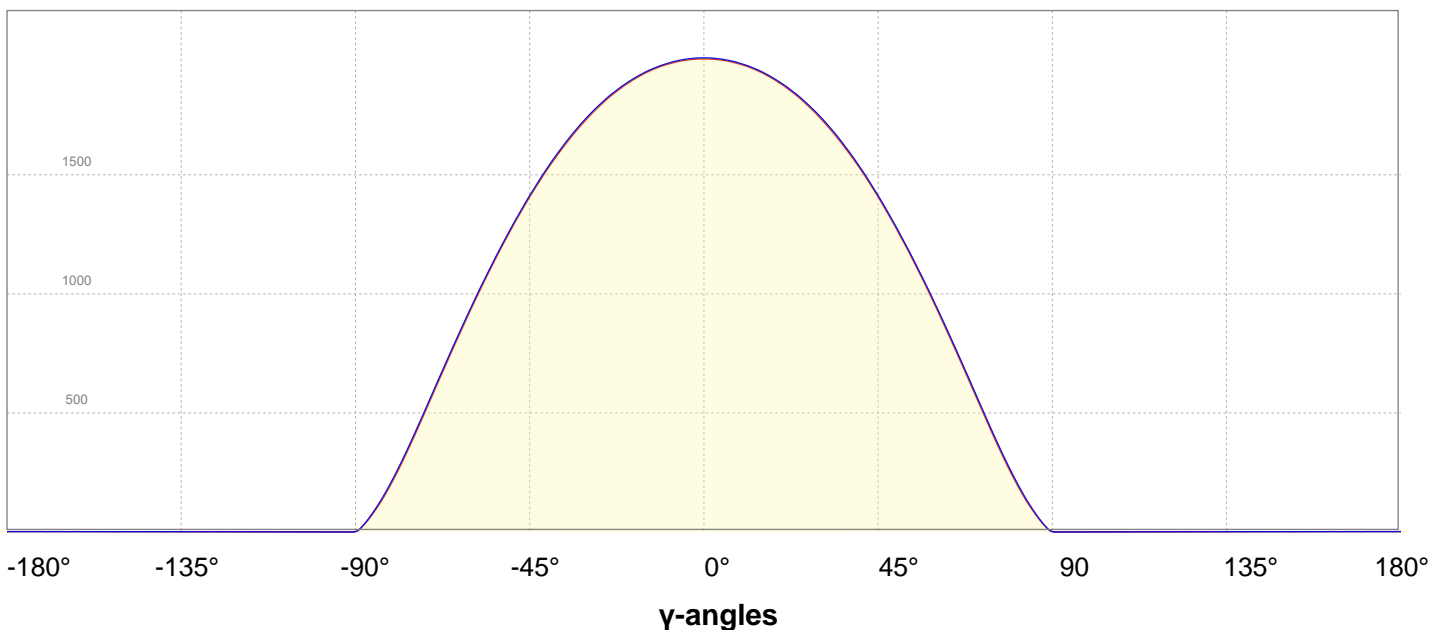
C000-C180
C090-C270
Linear Distribution Diagram – Intensity (candela) vs γ -angle

Beam Details

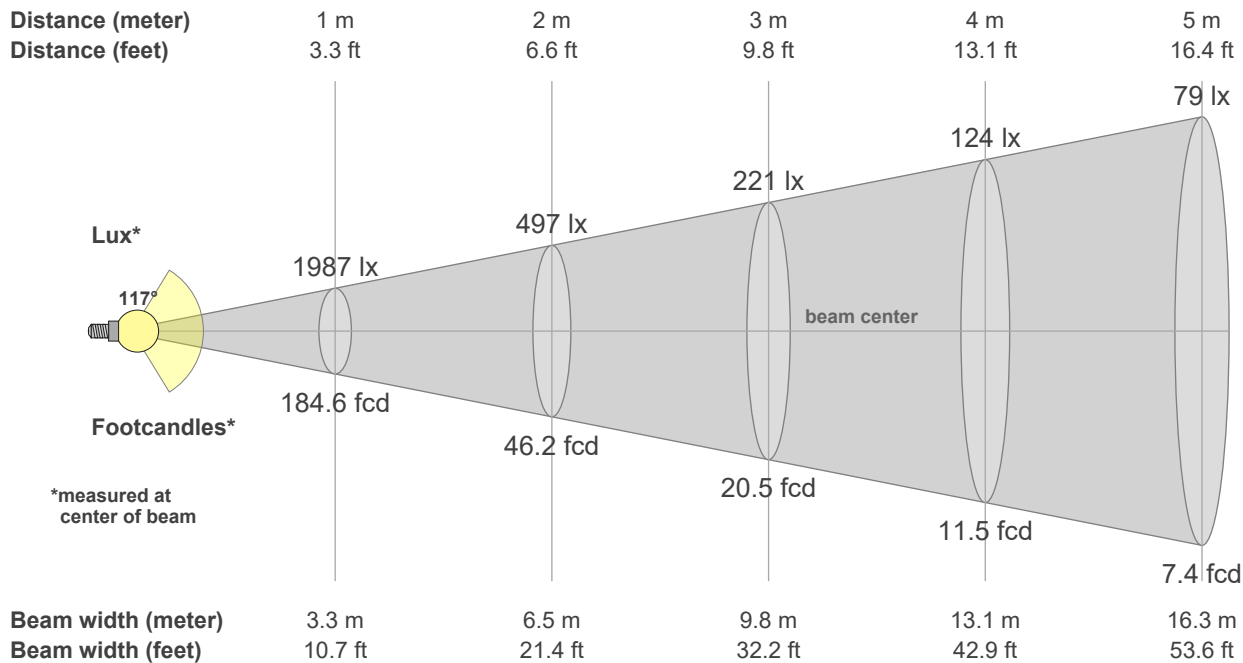

Beam intensities from 1 – 20m

1	2	3	4	5	6	7	8	9	10	11	12	13	14	15	16	17	18	19	20	m
3.3	6.6	9.8	13.1	16.4	19.7	23	26.2	29.5	32.8	36.1	39.4	42.7	45.9	49.2	52.5	55.8	59.1	62.3	65.6	ft
1987	497	221	124	79	55	41	31	25	20	16	14	12	10	9	8	7	6	6	5	lux
184.6	46.2	20.5	11.5	7.4	5.1	3.8	2.9	2.3	1.8	1.5	1.3	1.1	0.9	0.8	0.7	0.6	0.6	0.5	0.5	fc

Intensities in 0° c-plane

0°	5°	10°	15°	20°	25°	30°	35°	40°	45°	50°	55°	60°	65°	70°	75°	80°	85°	90°	95°	γ
1987	1980	1961	1928	1880	1817	1738	1643	1533	1406	1264	1108	941	763	578	395	226	89	3	0	cd
100%	100%	99%	97%	95%	91%	87%	83%	77%	71%	64%	56%	47%	38%	29%	20%	11%	4%	0%	0%	of 0°val

Intensities in 90° c-plane

0°	5°	10°	15°	20°	25°	30°	35°	40°	45°	50°	55°	60°	65°	70°	75°	80°	85°	90°	95°	γ
1987	1984	1965	1932	1885	1823	1745	1650	1539	1413	1271	1115	948	771	587	404	234	94	2	1	cd
100%	100%	99%	97%	95%	92%	88%	83%	77%	71%	64%	56%	48%	39%	30%	20%	12%	5%	0%	0%	of 0°val

Intensities in 180° c-plane {INT_TABLE_180_START}

•	•	•	•	•	•	•	•	•	•	•	•	•	•	•	•	•	•	•	•	γ	
																					cd
%	%	%	%	%	%	%	%	%	%	%	%	%	%	%	%	%	%	%	%	%	of 0°val

Intensities in 270° c-plane

0°	5°	10°	15°	20°	25°	30°	35°	40°	45°	50°	55°	60°	65°	70°	75°	80°	85°	90°	95°	γ
1987	1984	1965	1932	1885	1823	1745	1650	1539	1413	1271	1115	948	771	587	404	234	94	2	1	cd
100%	100%	99%	97%	95%	92%	88%	83%	77%	71%	64%	56%	48%	39%	30%	20%	12%	5%	0%	0%	Of 0°val



Colour Details

Correlated Colour Temperature, Target	CCT = 4000K
Correlated Colour Temperature, Measured	CCT = 3963K
Colour Rendering Index	CRI 83.4
Colour Rendering Index R9 Value	R9 = 11.9
Colour Rendering TM30-18	R _f 84.3, R _g 98.3
Colour Quality Scale	CQS = 83.0

MacAdam Steps	SDCM = 0.8
Colour Coordinates CIE 1931	(x;y) = (0.381;0.377)
Colour Coordinates CIEs 1960	(u;v) = (0.225; 0.334)
Colour Deviation from BBL	Duv = -0.0003
Colour Coordinate CIEs 1976 (CIELUV)	(u';v') = (0.225;0.502)

Colour Rendering Index per reference colour (CIE 1995)

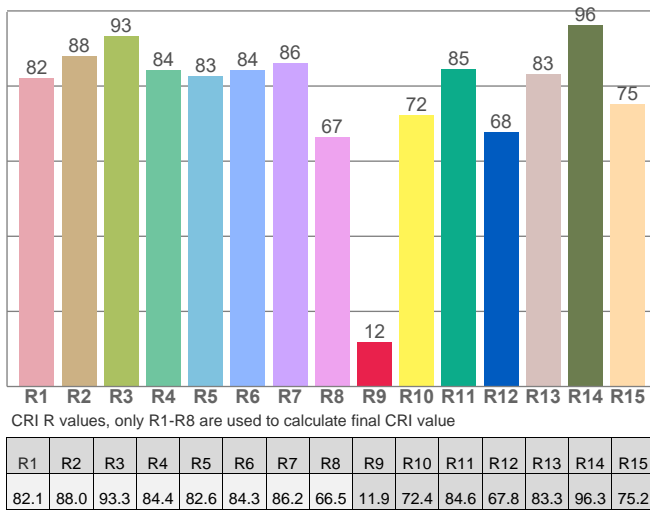

TM30-18 Rf-values per hue bin

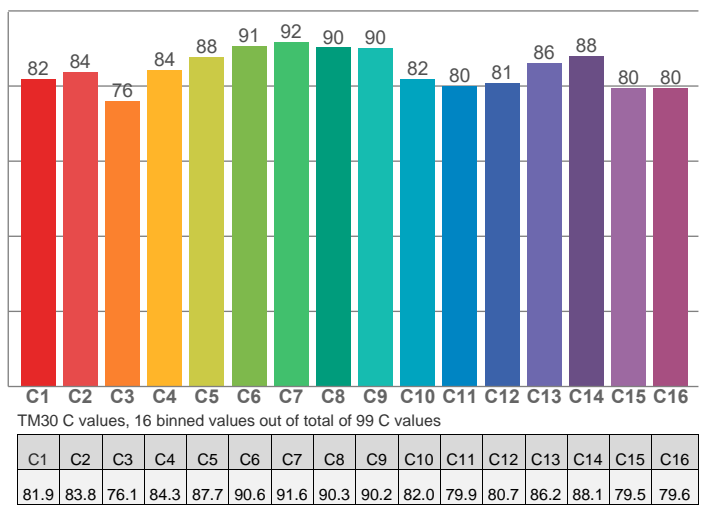

CIE 1931

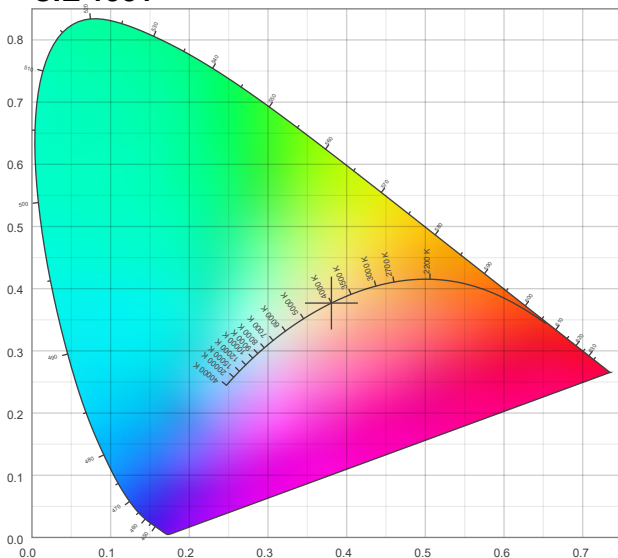

CIE 1931 – Zoomed

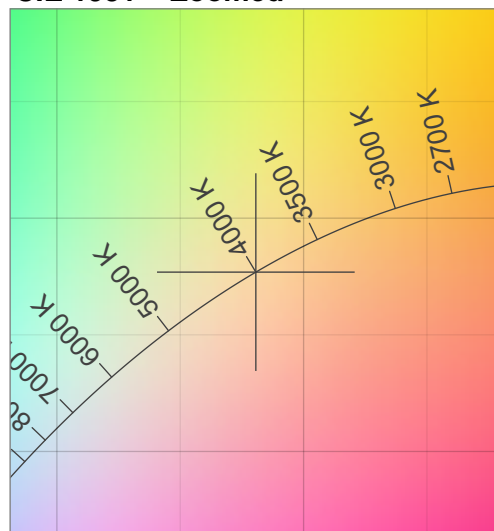

Iso-intensity Diagram (Iso-Candela)

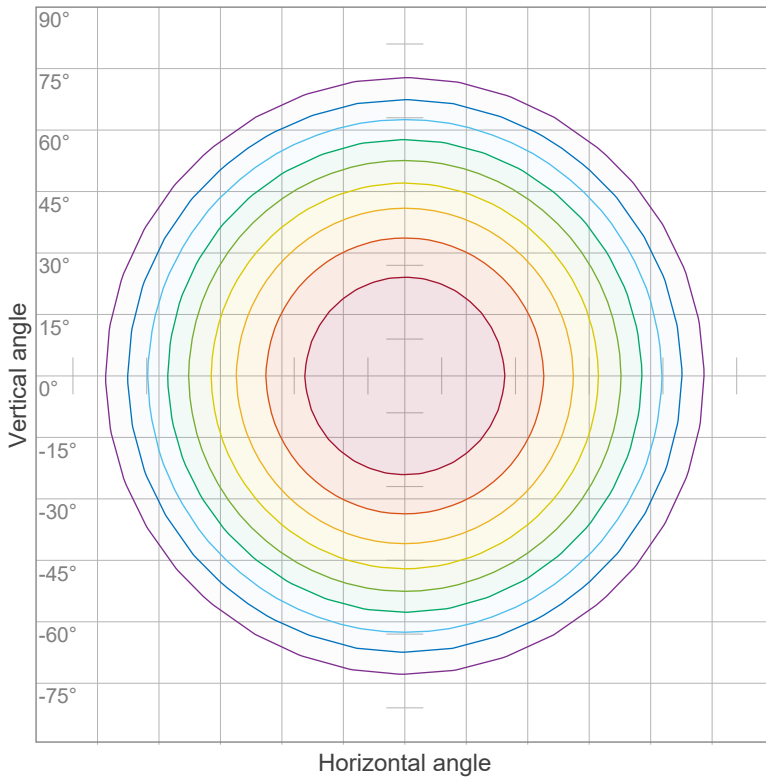

90 %	1791.4 cd
80 %	1592.4 cd
70 %	1393.3 cd
60 %	1194.3 cd
50 %	995.2 cd
40 %	796.2 cd
30 %	597.1 cd
20 %	398.1 cd
10 %	199.0 cd

Peak intensity: 1990.4 cd
Number of c-planes: 36

Iso-illuminance Diagram (Iso-lux)

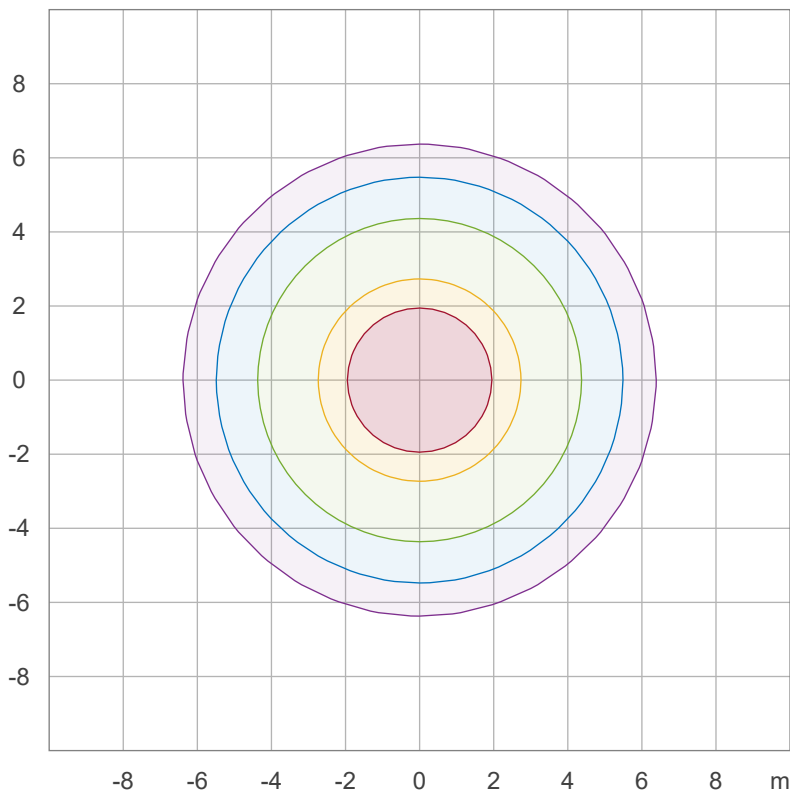

50.0 %	110.5 lx
30.0 %	66.3 lx
10.0 %	22.1 lx
5.0 %	11.1 lx
3.0 %	6.6 lx

Peak illuminance: 221.1 lx
Mounting height: 3.0 m
Number of c-planes: 36



Light Planning – UGR table

Uncorrected, comprehensive UGR table according to 117-1995

Reflectances		70	70	50	50	30	70	70	50	50	30
ρ Ceiling		70	70	50	50	30	70	70	50	50	30
ρ Walls		50	30	50	30	30	50	30	50	30	30
ρ Floor		20	20	20	20	20	20	20	20	20	20
Room size		Viewed Crosswise					Viewed Endwise				
H = mounting height above eye level											
X	Y	(Viewing direction orthogonal to lamp length axis)					(Viewing direction parallel to lamp length axis)				
2H	2H	19.8	21.0	20.0	21.3	21.5	19.8	21.0	20.0	21.3	21.5
	3H	21.2	22.4	21.6	22.7	22.9	21.2	22.5	21.6	22.8	23.0
	4H	21.7	22.9	22.1	23.2	23.5	21.8	23.0	22.2	23.3	23.5
	6H	22.2	23.2	22.5	23.5	23.9	22.2	23.3	22.5	23.6	23.9
	8H	22.2	23.3	22.6	23.6	24.0	22.3	23.3	22.6	23.6	24.1
	12H	22.3	23.3	22.6	23.6	24.1	22.3	23.3	22.7	23.7	24.1
4H	2H	20.4	21.6	20.8	21.8	22.1	20.4	21.6	20.8	21.9	22.1
	3H	22.1	23.1	22.4	23.4	23.9	22.1	23.1	22.5	23.4	23.9
	4H	22.7	23.6	23.1	24.0	24.6	22.7	23.6	23.1	24.0	24.6
	6H	23.1	24.0	23.6	24.4	24.7	23.2	24.1	23.7	24.4	24.8
	8H	23.3	24.1	23.8	24.4	24.8	23.3	24.1	23.8	24.5	24.9
	12H	23.3	24.0	23.8	24.4	24.9	23.4	24.1	23.9	24.5	25.0
8H	4H	22.9	23.7	23.4	24.1	24.5	23.0	23.8	23.5	24.1	24.5
	6H	23.5	24.1	24.0	24.6	25.1	23.6	24.2	24.1	24.7	25.2
	8H	23.7	24.3	24.2	24.8	25.4	23.8	24.3	24.3	24.9	25.5
	12H	23.8	24.3	24.4	24.8	25.4	23.9	24.4	24.5	24.9	25.5
12H	4H	22.9	23.6	23.4	24.0	24.5	23.0	23.6	23.5	24.1	24.5
	6H	23.6	24.1	24.1	24.6	25.3	23.6	24.2	24.1	24.7	25.3
	8H	23.8	24.2	24.4	24.8	25.4	23.9	24.3	24.4	24.8	25.4

Variations with the observer position for the luminaire spacings, S:

S = 1.0H	0.1 / -0.1	0.1 / -0.1
S = 1.5H	0.2 / -0.3	0.2 / -0.3
S = 2.0H	0.5 / -0.6	0.5 / -0.5

Coefficients of Utilization

Ceiling reflectance	80	70	50	30	10	0												
Wall reflectance	70	50	30	10	70	50	30	10	50	30	10	50	30	10	0			
Floor reflectance	20	20	20	20	20	20	20	20	20	20	20	20	20	20	0			
RCR	(RCR: Room Cavity Ratio)																	
	Room Values are expressed as percentage of Lumen delivered to the task surface																	
0	119	119	119	119	116	116	116	116	111	111	111	106	106	106	102	102	102	100
1	109	104	99	96	106	101	98	94	97	94	91	93	91	88	90	87	85	83
2	99	90	83	77	96	88	82	77	85	79	75	81	77	73	78	75	71	69
3	90	79	71	64	87	77	70	64	74	68	62	72	66	61	69	64	60	58
4	82	70	61	54	80	68	60	54	66	59	53	64	57	52	61	56	51	49
5	75	62	53	46	73	61	53	46	59	51	46	57	50	45	55	49	45	42
6	69	56	47	40	68	55	46	40	53	46	40	51	45	39	50	44	39	37
7	64	51	42	36	63	50	41	35	48	41	35	47	40	35	45	39	35	33
8	60	46	38	32	58	45	37	32	44	37	31	43	36	31	42	36	31	29
9	56	42	34	28	54	42	34	28	41	33	28	39	33	28	38	32	28	26
10	52	39	31	26	51	38	31	26	37	30	26	37	30	25	36	30	25	23



Flicker Details

Flicker Meter Type	Viso Systems LabFlicker
Frequency of Input Power	60Hz
Flicker/TLA Sample Rate	20000 sample/s
Measurement Time	
PstLM	180 sec
All other indices	1.2 sec

Flicker Indices (IES)	
Flicker Percentage	1.31%
Flicker Frequency	120.48Hz
Flicker Index	0
Flicker SVM Value	0.04
Flicker PstLM Value	0.03

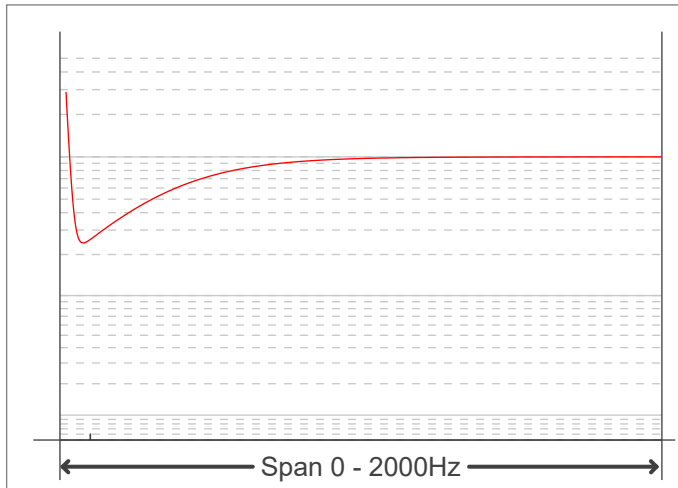
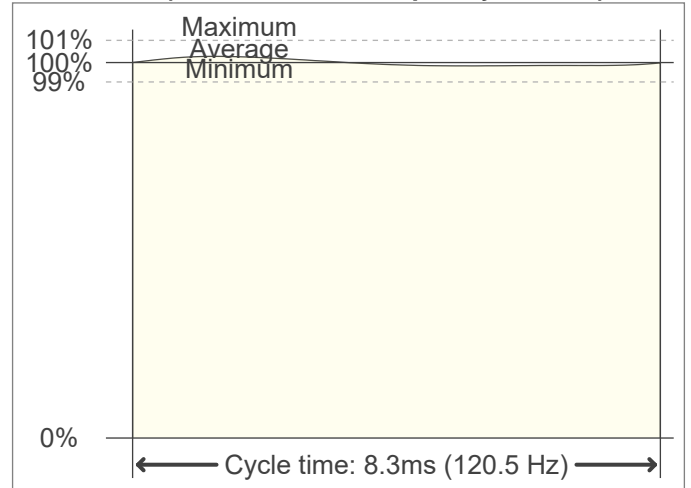
Flicker Frame

Flicker FFT (flicker curve in frequency domain)

IEEE 1789 Frequency/Modulation Plot
