



TECHLUME

A U S T R A L I A

LM-79 Test Report

Testing Method:	IES Approved Method: Electrical and Photometric Measurements of Solid-State Lighting Products
Relevant Standards:	IES LM-79-08
Test Date and Time:	24/04/2023 3:51:00 PM
Test Location:	Techlume Australia - East Goderich Street Deloraine, TAS 7304
Operator:	Johnny Elmer
Measurement Number:	VFR-230424-0066-MS
Measurement Method:	Far Field, Type C Horizontal
Measurement Distance:	464.4 cm

Equipment Used

System Name:	LabSpion Goniometer
Sensor Name / Model:	Viso LabSensor Model2 / Freedom VIS (Custom Viso)
Spectrometer Range:	360 nm – 830 nm
Calibration Date:	7/12/2022
Flicker Meter Type:	Viso Systems LabFlicker
Manufacturer:	Viso Systems, Denmark

Test Conditions

Ambient Temperature:	25 °C ± 1 °C
----------------------	--------------

Remarks

The results stated in this report represent the tested sample only. All photometric and colourimetric data has been measured in compliance with IES LM-79-08 standards.



Product Overview

Product Description:

DUELL 10W Downlight, White Trim, 2-colour (3000K/4000K), IP54, Phase Dim

Item Number:

LC3579 - 3000K

Manufacturer:

Decrolux ighting Pty Ltd

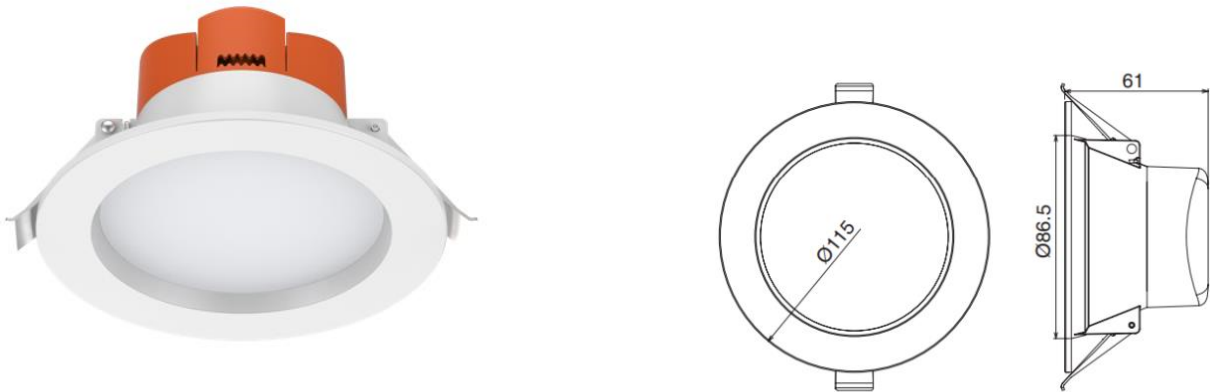

Photometric Measurements

Total Luminous Flux	Luminous Efficacy	Luminous Intensity
961 lm	93 Lumen/watt	411 cd

Correlated Colour Temperature, Target	Correlated Colour Temperature, Measured	Colour Rendering Index (CRI)
3000 K	2918 K	Ra 81.7

Electrical Measurements

Input Voltage	Input Current	Input Power	Input Voltage Frequency
240 VAC	0.047 A	10.4 W	60 Hz

Power Factor	Stabilisation Time	Stabilisation Variation	Hours Operated Prior to Test
0.92	Lamp stabilized in 53 min 38 sec	-6.1%	0 hours



Spectral Power Distribution (SPD)

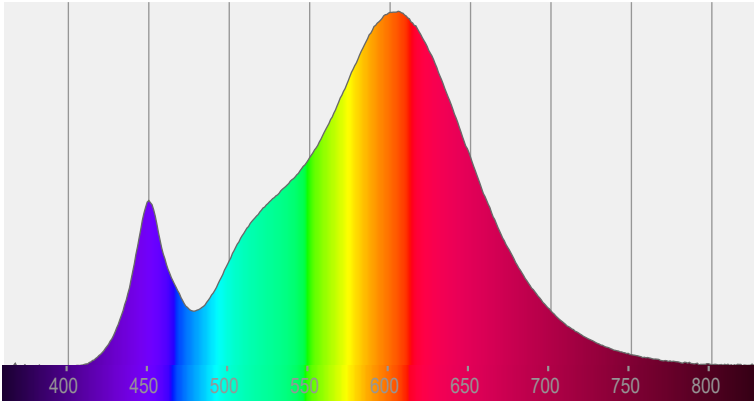

Input Power Curve

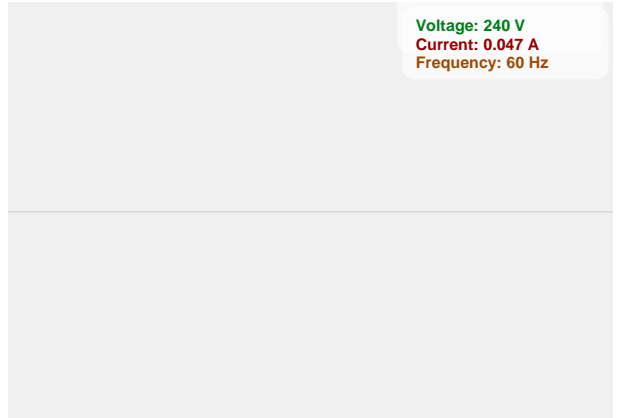

Flicker Details

Flicker Sample Rate	Flicker Percentage	Flicker Frequency	Flicker Index
20000 sample/s	10.78%	120.48 Hz	0.03

Flicker SVM Value	Flicker PstLM Value	Measurement Time (PstLM)	Measurement Time (all other indices)
0.37	0.42	180 s	1.2 s

IEEE 1789 Frequency/Modulation Plot

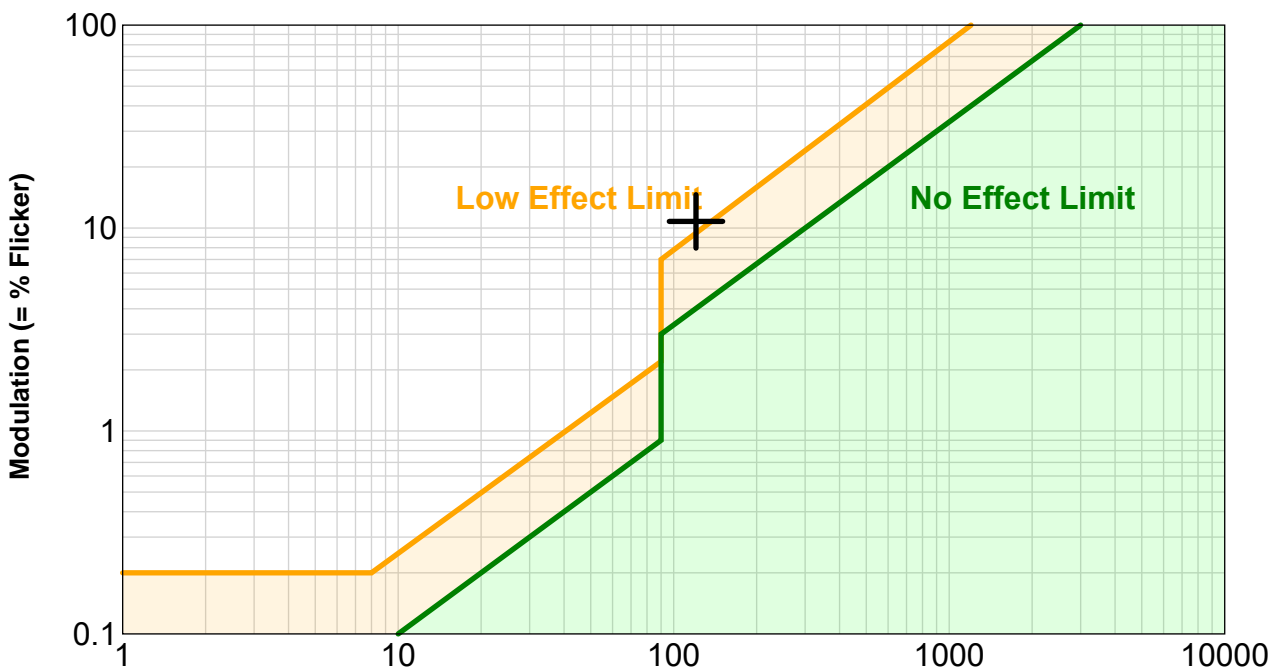

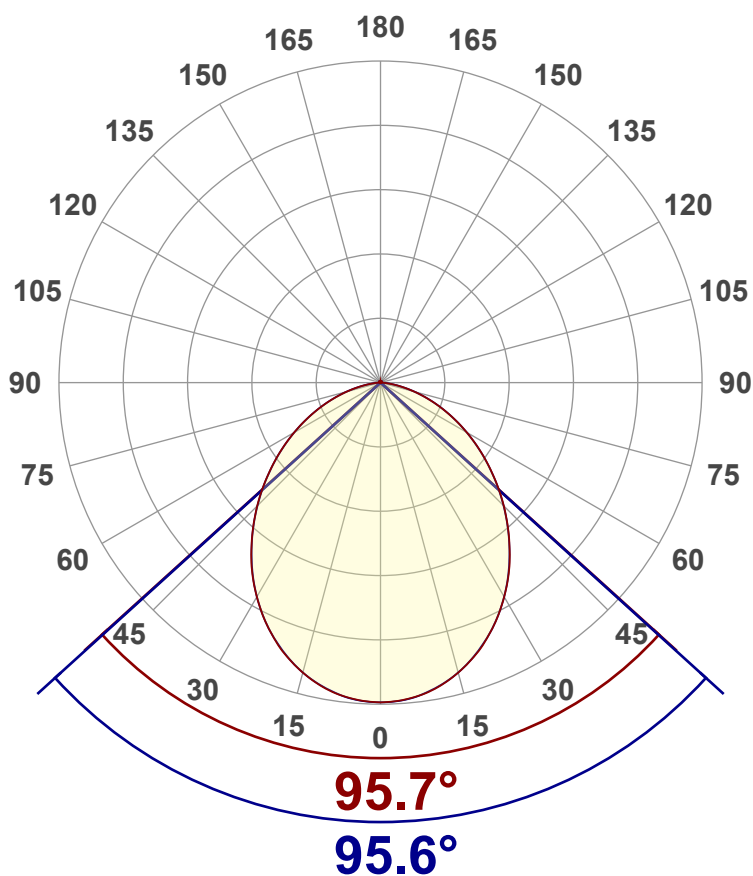
Angular Distribution – 0° / 90° Plane

Main Values

Total Lumen Output	961 lm
Lumen Up%	0.61%
Lumen Down%	99.39%
Peak Intensity	411 cd
Beam Angle (90%)	95.6°

Cut-off Angle

Average 2.5%	167.7°
---------------------	--------

Field Angle

Average 10%	151.7°
--------------------	--------

Intensity Ratio

In 120° Cone	83.2%
In 90° Cone	59.7%

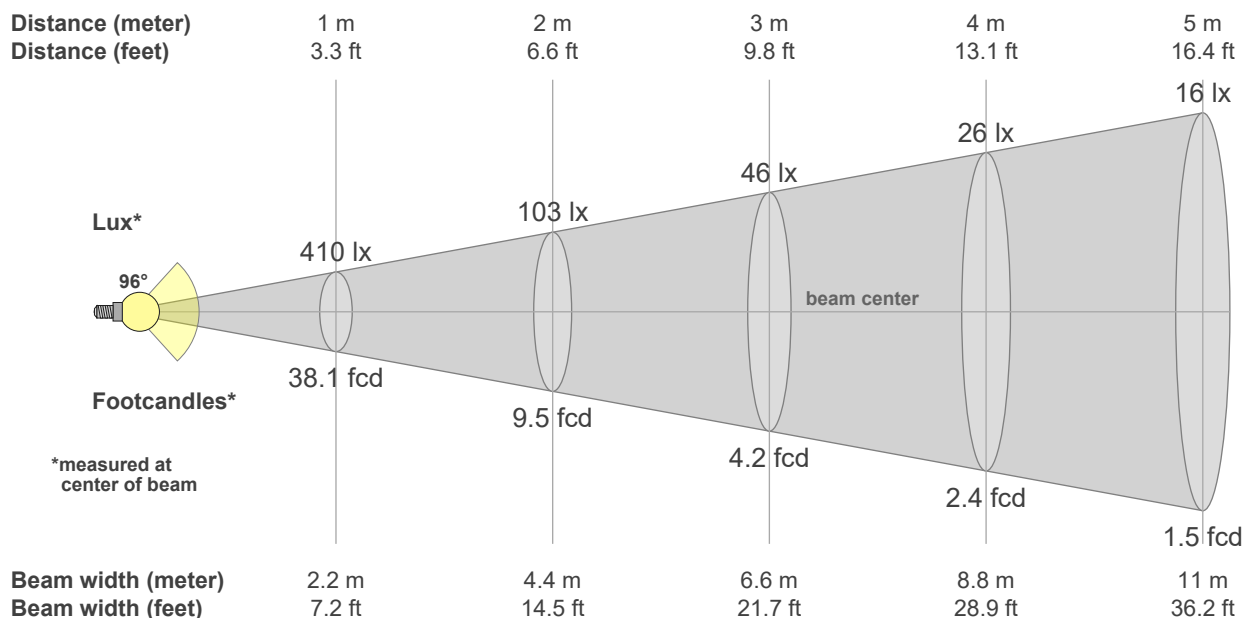
C000-C180
C090-C270

Beam intensities from 1 – 20m

1	2	3	4	5	6	7	8	9	10	11	12	13	14	15	16	17	18	19	20	m
3.3	6.6	9.8	13.1	16.4	19.7	23	26.2	29.5	32.8	36.1	39.4	42.7	45.9	49.2	52.5	55.8	59.1	62.3	65.6	ft
410	103	46	26	16	11	8	6	5	4	3	3	2	2	2	2	1	1	1	1	lux
38.1	9.5	4.2	2.4	1.5	1.1	0.8	0.6	0.5	0.4	0.3	0.3	0.2	0.2	0.2	0.1	0.1	0.1	0.1	0.1	fc



Colour Details

Colour Rendering Index (CRI)	Colour Rendering Index R9 Value	Colour Rendering TM30-18
Ra 81.7	R9 = 4.0	R _f 84.0, R _g 96.6

Colour Quality Scale	Correlated Colour Temperature, Target	Correlated Colour Temperature, Measured
CQS = 80.9	CCT = 3000 K	CCT = 2918 K

MacAdam Steps	Colour Coordinates CIE 1931	Colour Deviation from BBL
SDCM = 2.9	(x;y) = (0.437;0.404)	Duv = -0.0005

Colour Rendering Index per reference colour (CIE 1995)

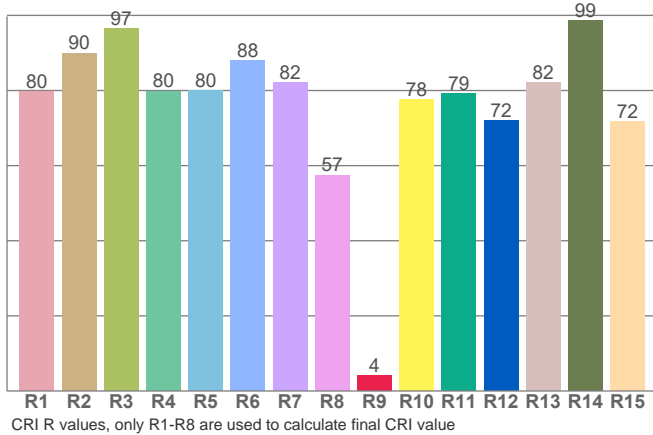

R1	R2	R3	R4	R5	R6	R7	R8	R9	R10	R11	R12	R13	R14	R15
79.8	90.0	96.5	79.9	79.9	88.0	82.1	57.4	4.0	77.5	79.2	72.0	82.1	98.6	71.6

TM30-18 R_f-values per hue bin

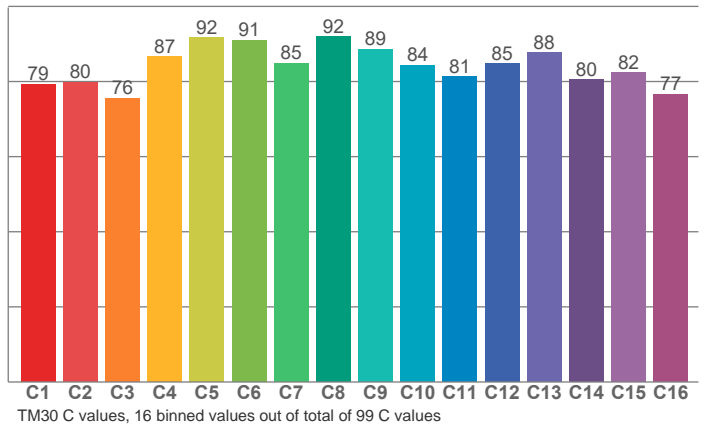

C1	C2	C3	C4	C5	C6	C7	C8	C9	C10	C11	C12	C13	C14	C15	C16
79.3	79.8	75.5	86.6	91.6	91.0	84.9	92.0	88.7	84.4	81.3	84.7	87.7	80.4	82.4	76.7

CIE 1931

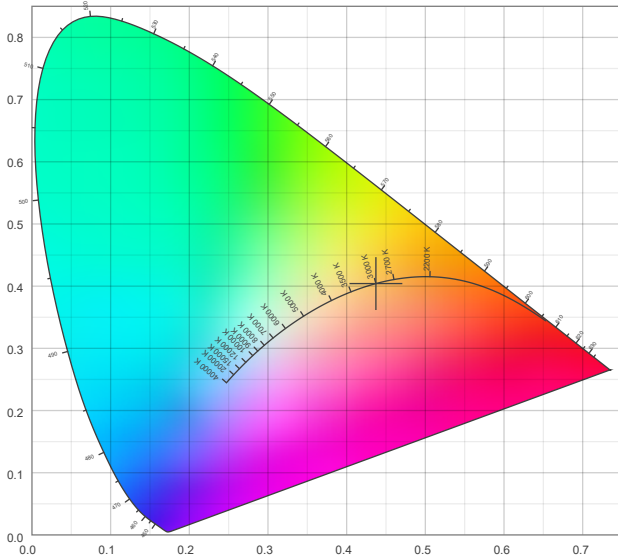

CIE 1931 – Zoomed

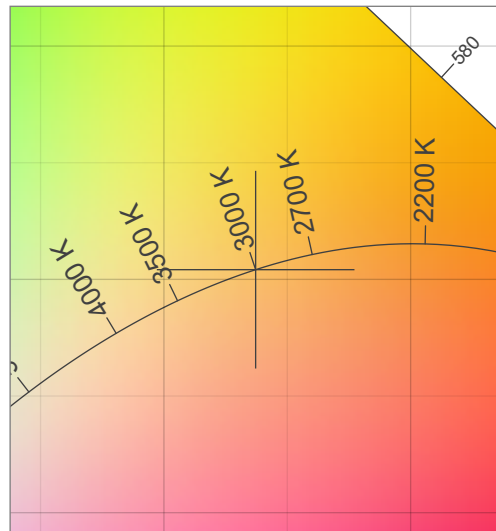

Iso-intensity Diagram (Iso-Candela)

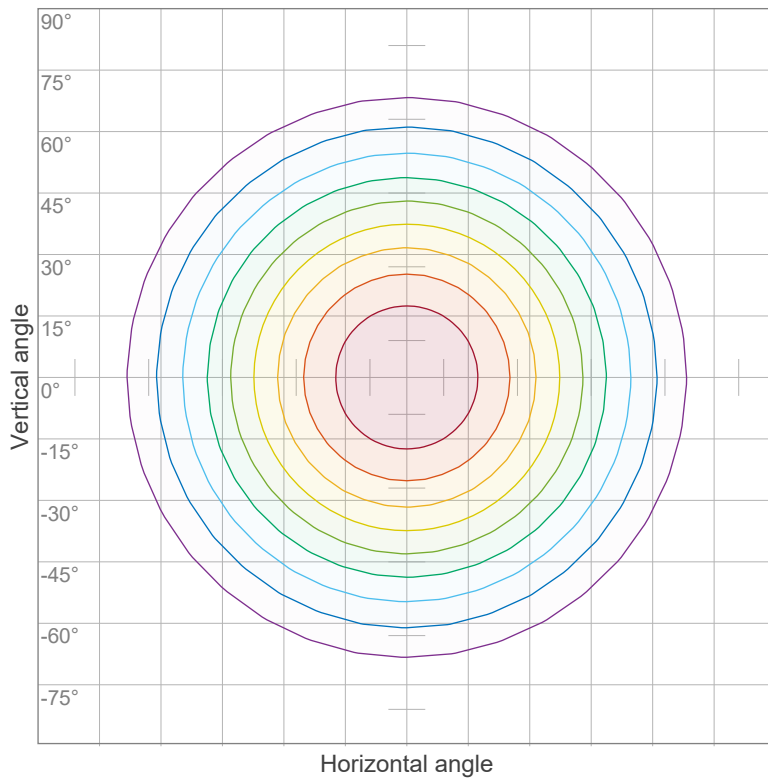

90 %	369.6 cd
80 %	328.5 cd
70 %	287.4 cd
60 %	246.4 cd
50 %	205.3 cd
40 %	164.2 cd
30 %	123.2 cd
20 %	82.1 cd
10 %	41.1 cd

Peak intensity: 410.6 cd
Number of c-planes: 36

Iso-illuminance Diagram (Iso-lux)

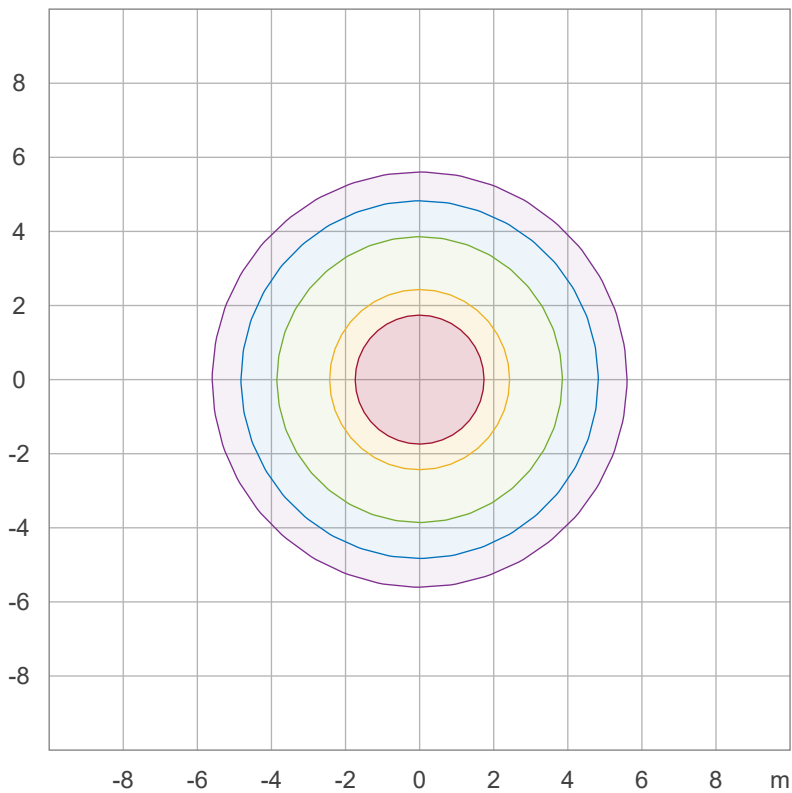

50.0 %	22.8 lx
30.0 %	13.7 lx
10.0 %	4.6 lx
5.0 %	2.3 lx
3.0 %	1.4 lx

Peak illuminance: 45.6 lx
Mounting height: 3.0 m
Number of c-planes: 36



Light Planning – UGR table

Uncorrected, comprehensive UGR table according to 117-1995

Reflectances		70	70	50	50	30	70	70	50	50	30
ρ Ceiling		70	70	50	50	30	70	70	50	50	30
ρ Walls		50	30	50	30	30	50	30	50	30	30
ρ Floor		20	20	20	20	20	20	20	20	20	20
Room size		Viewed Crosswise					Viewed Endwise				
H = mounting height above eye level		(Viewing direction orthogonal to lamp length axis)					(Viewing direction parallel to lamp length axis)				
X	Y										
2H	2H	24.3	25.4	24.5	25.8	26.0	24.3	25.4	24.5	25.7	26.0
	3H	25.2	26.4	25.6	26.7	26.9	25.2	26.4	25.6	26.6	26.9
	4H	25.5	26.6	25.9	26.9	27.2	25.5	26.6	25.9	26.9	27.2
	6H	25.7	26.7	26.0	27.0	27.4	25.7	26.7	26.0	27.0	27.3
	8H	25.7	26.7	26.1	27.0	27.4	25.7	26.6	26.0	27.0	27.4
	12H	25.7	26.6	26.1	27.0	27.4	25.7	26.6	26.0	26.9	27.4
4H	2H	24.7	25.8	25.1	26.1	26.4	24.7	25.8	25.1	26.1	26.4
	3H	25.9	26.8	26.3	27.2	27.6	25.9	26.8	26.3	27.2	27.6
	4H	26.2	27.1	26.7	27.5	28.0	26.2	27.0	26.6	27.5	28.0
	6H	26.4	27.2	26.9	27.6	28.0	26.4	27.2	26.9	27.6	27.9
	8H	26.4	27.2	27.0	27.6	28.0	26.4	27.2	26.9	27.5	27.9
	12H	26.4	27.0	26.9	27.5	28.0	26.4	27.0	26.9	27.4	27.9
8H	4H	26.3	27.1	26.8	27.4	27.8	26.3	27.1	26.8	27.4	27.8
	6H	26.6	27.2	27.1	27.6	28.2	26.6	27.1	27.1	27.6	28.2
	8H	26.7	27.2	27.2	27.7	28.4	26.7	27.1	27.2	27.7	28.3
	12H	26.7	27.1	27.3	27.6	28.2	26.7	27.1	27.3	27.6	28.2
12H	4H	26.3	26.9	26.8	27.3	27.8	26.3	26.9	26.8	27.3	27.8
	6H	26.6	27.1	27.2	27.6	28.3	26.6	27.1	27.1	27.6	28.3
	8H	26.7	27.1	27.3	27.6	28.2	26.7	27.1	27.3	27.6	28.2
Variations with the observer position for the luminaire spacings, S:											
S = 1.0H		0.2 / -0.3					0.2 / -0.3				
S = 1.5H		0.4 / -0.7					0.4 / -0.7				
S = 2.0H		0.9 / -1.3					0.9 / -1.3				

Coefficients of Utilization

Ceiling reflectance	80			70			50			30			10			0		
Wall reflectance	70	50	30	10	70	50	30	10	50	30	10	50	30	10	50	30	10	0
Floor reflectance	20	20	20	20	20	20	20	20	20	20	20	20	20	20	20	20	20	0
RCR (RCR: Room Cavity Ratio)																		
Room Values are expressed as percentage of Lumen delivered to the task surface																		
0	119	119	119	119	116	116	116	116	111	111	111	106	106	106	101	101	101	99
1	110	105	101	98	107	103	99	96	99	96	93	95	92	90	91	89	87	85
2	100	93	86	81	98	91	85	80	87	82	78	84	80	76	81	77	74	72
3	92	82	74	68	90	80	73	68	77	71	66	75	69	65	72	68	64	62
4	85	73	65	59	82	72	64	58	69	63	57	67	61	56	65	60	56	54
5	78	66	57	51	76	65	57	51	62	55	50	60	54	49	59	53	49	47
6	72	60	51	45	70	59	50	45	57	50	44	55	49	44	53	48	43	41
7	67	54	46	40	65	53	45	40	52	45	39	50	44	39	49	43	39	37
8	63	50	41	36	61	49	41	36	48	40	35	46	40	35	45	39	35	33
9	59	46	38	32	57	45	37	32	44	37	32	43	36	32	42	36	32	30
10	55	42	35	29	54	42	34	29	41	34	29	40	33	29	39	33	29	27

NOTE: An asymmetry correction has been applied to the beam distribution of this measurement in order to accurately calculate UGR.

