

# TECHLUME

## A U S T R A L I A

### LM-79 Test Report

Testing Method:	IES Approved Method: Electrical and Photometric Measurements of Solid-State Lighting Products
Relevant Standards:	IES LM-79-08
Test Date and Time:	28/03/2023 3:44:41 PM
Test Location:	Techlume Australia - East Goderich Street Deloraine, TAS 7304
Operator:	Johnny Elmer
Measurement Number:	VFR-230328-0027-MS
Measurement Method:	Far Field, Type C Horizontal
Measurement Distance:	457.7 cm

#### Equipment Used

System Name:	LabSpion Goniometer
Sensor Name / Model:	Viso LabSensor Model2 / Freedom VIS (Custom Viso)
Spectrometer Range:	360 nm – 830 nm
Calibration Date:	7/12/2022
Flicker Meter Type:	Viso Systems LabFlicker
Manufacturer:	Viso Systems, Denmark

#### Test Conditions

Ambient Temperature:	25 °C ± 1 °C
----------------------	--------------

#### Remarks

The results stated in this report represent the tested sample only. All photometric and colourimetric data has been measured in compliance with IES LM-79-08 standards.



### Product Overview

Product Description: EMPRESS 13W Fixed Downlight, Black, 3000K, 60°, IP65, Phase Dim

Item Number: LC3590B

Manufacturer: Decrolux Lighting Pty Ltd

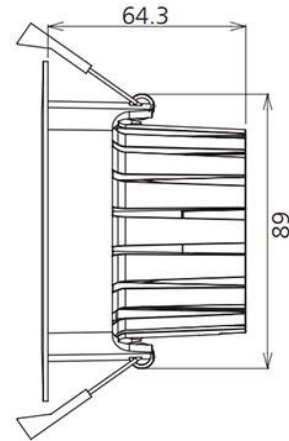

### Photometric Measurements

Total Luminous Flux	Luminous Efficacy	Luminous Intensity
1237 lm	109 Lumen/watt	1198 cd

Correlated Colour Temperature, Target	Correlated Colour Temperature, Measured	Colour Rendering Index (CRI)
3000 K	2999 K	Ra 83.3

### Electrical Measurements

Input Voltage	Input Current	Input Power	Input Voltage Frequency
240 VAC	0.050 A	11.4 W	60 Hz

Power Factor	Stabilisation Time	Stabilisation Variation	Hours Operated Prior to Test
0.95	Lamp stabilized in 15 min 5 sec	-0.5%	0 hours



### Spectral Power Distribution (SPD)

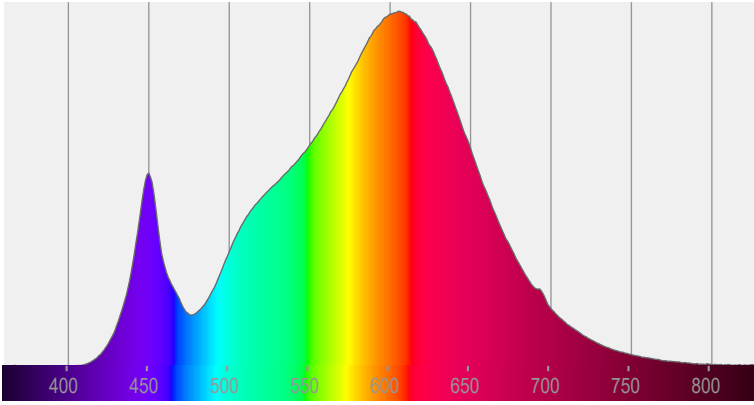

### Input Power Curve

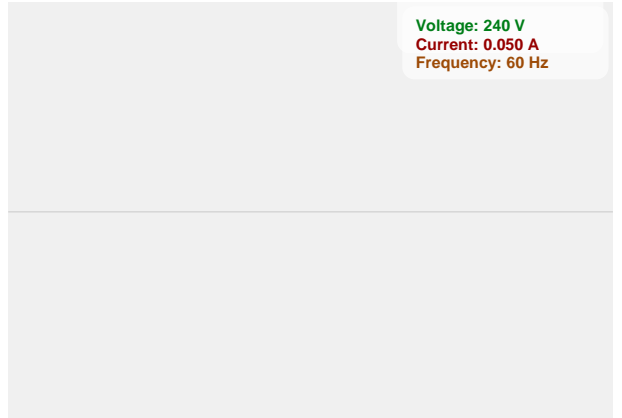

### Flicker Details

Flicker Sample Rate	Flicker Percentage	Flicker Frequency	Flicker Index
20000 sample/s	2.28%	119.76 Hz	0

Flicker SVM Value	Flicker PstLM Value	Measurement Time (PstLM)	Measurement Time (all other indices)
0.02	0	180 s	1.2 s

### IEEE 1789 Frequency/Modulation Plot

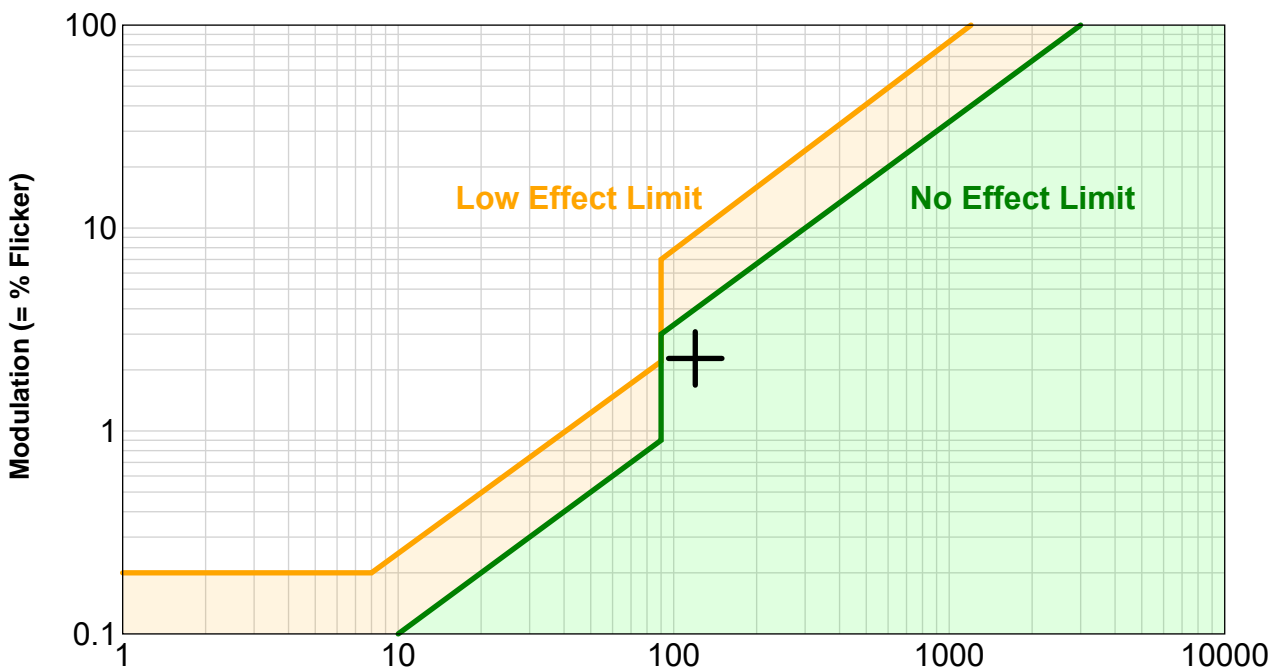

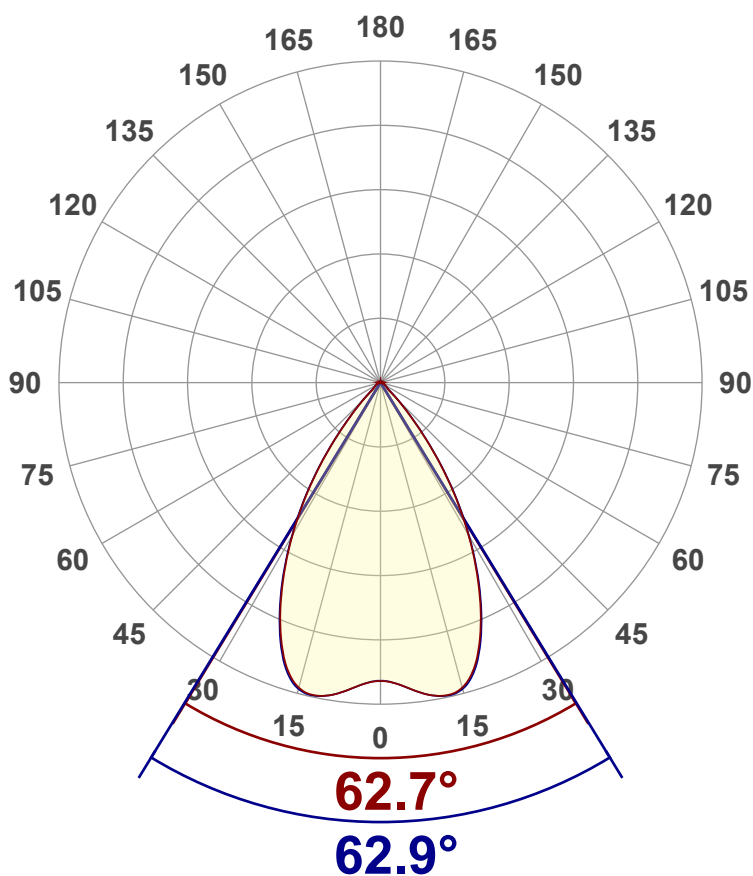
**Angular Distribution – 0° / 90° Plane**

**Main Values**

<b>Total Lumen Output</b>	1237 lm
<b>Lumen Up%</b>	0.32%
<b>Lumen Down%</b>	99.68%
<b>Peak Intensity</b>	1198 cd
<b>Beam Angle (90%)</b>	62.9°

**Cut-off Angle**

<b>Average 2.5%</b>	106.4°
---------------------	--------

**Field Angle**

<b>Average 10%</b>	87.4°
--------------------	-------

**Intensity Ratio**

<b>In 120° Cone</b>	98.1%
<b>In 90° Cone</b>	94.3%

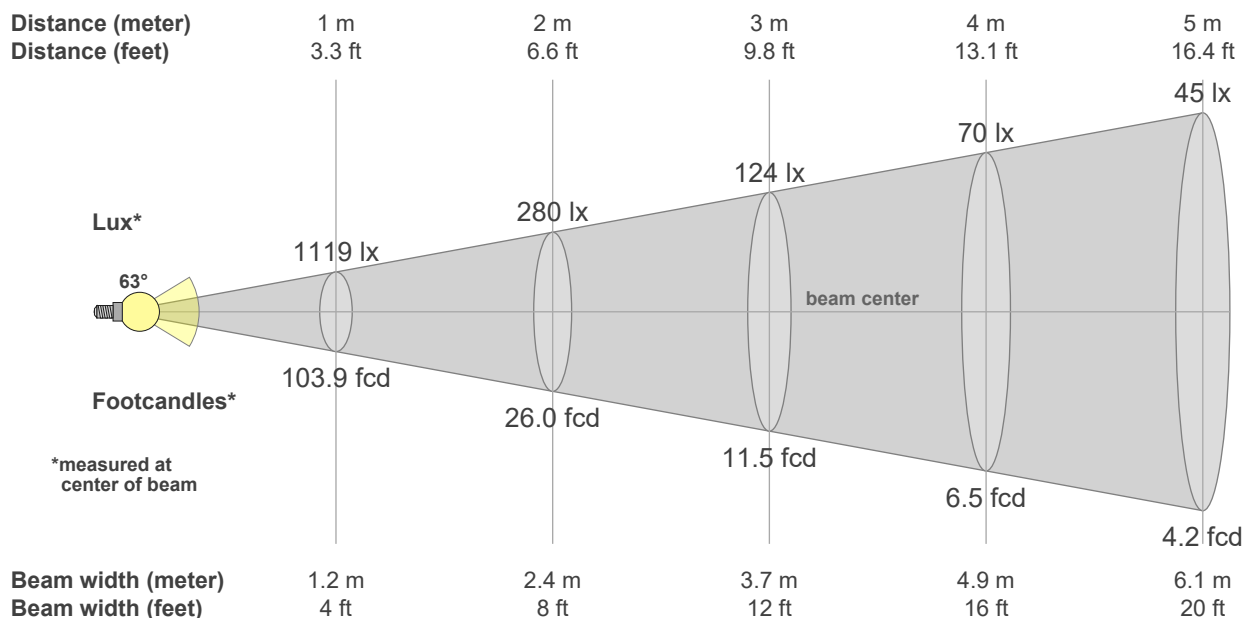
**C000-C180**
**C090-C270**

**Beam intensities from 1 – 20m**

1	2	3	4	5	6	7	8	9	10	11	12	13	14	15	16	17	18	19	20	m
<b>3.3</b>	6.6	9.8	13.1	16.4	19.7	23	26.2	29.5	32.8	36.1	39.4	42.7	45.9	49.2	52.5	55.8	59.1	62.3	65.6	ft
<b>1119</b>	280	124	70	45	31	23	17	14	11	9	8	7	6	5	4	4	3	3	3	lux
<b>103.9</b>	26	11.5	6.5	4.2	2.9	2.1	1.6	1.3	1	0.9	0.7	0.6	0.5	0.5	0.4	0.4	0.3	0.3	0.3	fc



**Colour Details**

Colour Rendering Index (CRI)	Colour Rendering Index R9 Value	Colour Rendering TM30-18
Ra 83.3	R9 = 11.8	Rf 84.9, Rg 97.7

Colour Quality Scale	Correlated Colour Temperature, Target	Correlated Colour Temperature, Measured
CQS = 82.4	CCT = 3000 K	CCT = 2999 K

MacAdam Steps	Colour Coordinates CIE 1931	Colour Deviation from BBL
SDCM = 0.3	(x;y) = (0.437;0.404)	Duv = 0.0003

**Colour Rendering Index per reference colour (CIE 1995)**

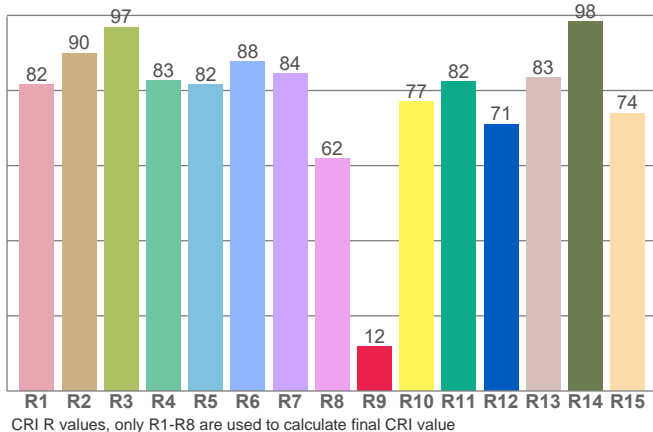

R1	R2	R3	R4	R5	R6	R7	R8	R9	R10	R11	R12	R13	R14	R15
81.6	89.9	96.8	82.6	81.5	87.6	84.5	61.9	11.8	77.0	82.3	71.0	83.4	98.3	74.0

**TM30-18 Rf-values per hue bin**

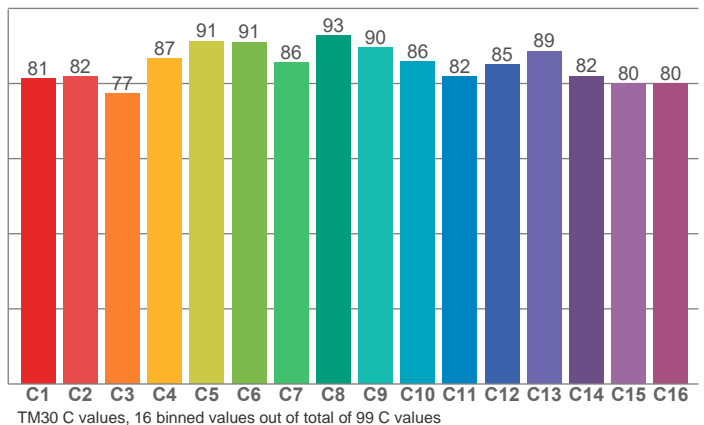

C1	C2	C3	C4	C5	C6	C7	C8	C9	C10	C11	C12	C13	C14	C15	C16
81.2	81.9	77.3	86.7	91.2	91.0	85.5	92.8	89.6	85.7	81.8	85.0	88.7	82.0	80.0	79.9

**CIE 1931**

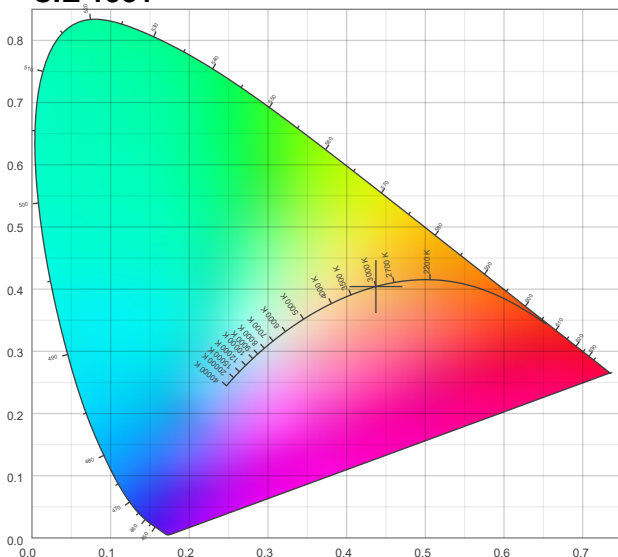

**CIE 1931 – Zoomed**

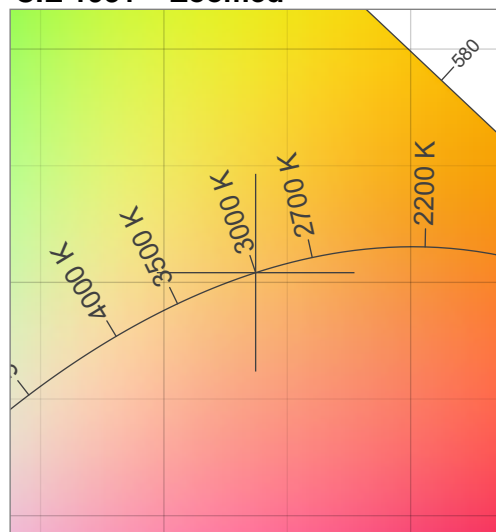

**Iso-intensity Diagram (Iso-Candela)**

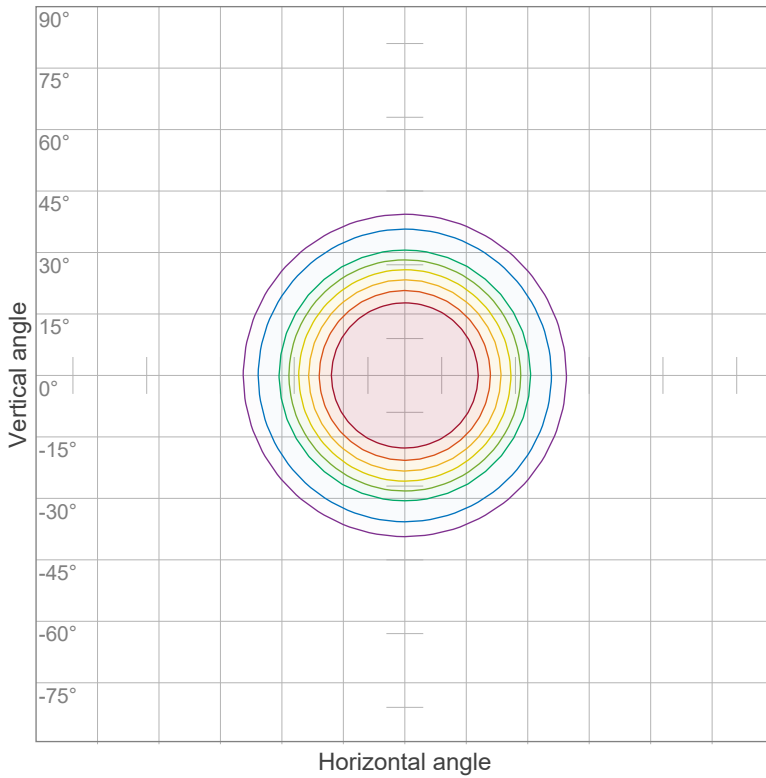

90 %	1078.1 cd
80 %	958.3 cd
70 %	838.6 cd
60 %	718.8 cd
50 %	599.0 cd
40 %	479.2 cd
30 %	359.4 cd
20 %	239.6 cd
10 %	119.8 cd

Peak intensity: 1197.9 cd  
Number of c-planes: 36

**Iso-illuminance Diagram (Iso-lux)**

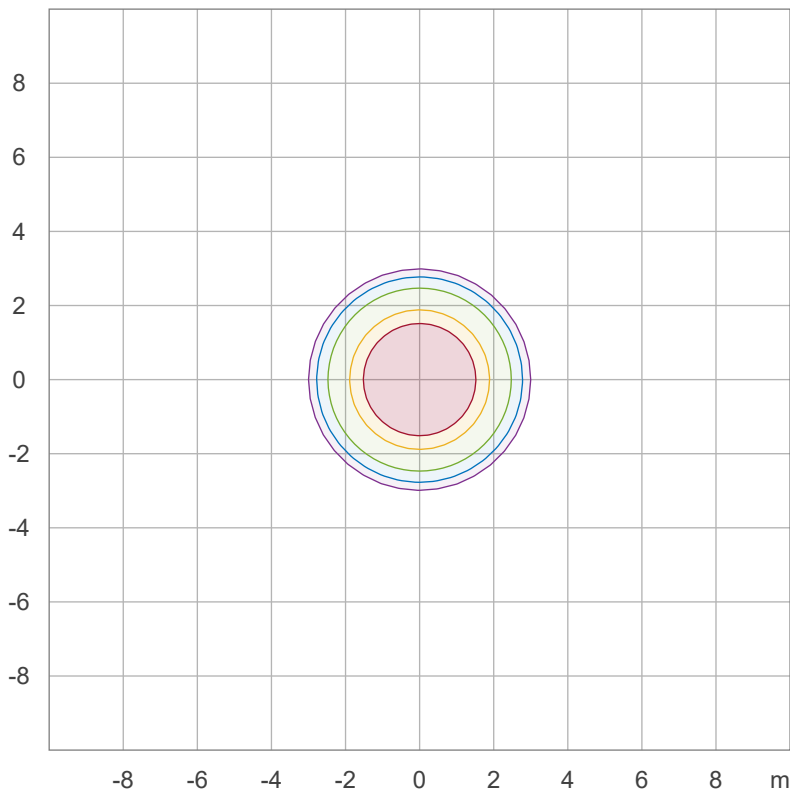

50.0 %	63.4 lx
30.0 %	38.1 lx
10.0 %	12.7 lx
5.0 %	6.3 lx
3.0 %	3.8 lx

Peak illuminance: 126.9 lx  
Mounting height: 3.0 m  
Number of c-planes: 36



**Light Planning – UGR table**

*Uncorrected, comprehensive UGR table according to 117-1995*

Reflectances		70	70	50	50	30	70	70	50	50	30
ρ Ceiling		70	70	50	50	30	70	70	50	50	30
ρ Walls		50	30	50	30	30	50	30	50	30	30
ρ Floor		20	20	20	20	20	20	20	20	20	20
Room size		Viewed Crosswise					Viewed Endwise				
H = mounting height above eye level		(Viewing direction orthogonal to lamp length axis)					(Viewing direction parallel to lamp length axis)				
X	Y										
2H	2H	21.5	22.2	21.7	22.5	22.7	21.6	22.3	21.7	22.5	22.7
	3H	21.3	22.2	21.7	22.4	22.6	21.4	22.2	21.8	22.4	22.6
	4H	21.3	22.1	21.7	22.3	22.5	21.3	22.1	21.7	22.3	22.6
	6H	21.3	21.9	21.6	22.2	22.6	21.3	22.0	21.6	22.3	22.6
	8H	21.2	21.9	21.6	22.2	22.6	21.3	21.9	21.6	22.2	22.6
	12H	21.2	21.8	21.5	22.1	22.6	21.2	21.8	21.6	22.2	22.6
4H	2H	21.2	22.0	21.6	22.3	22.5	21.3	22.1	21.7	22.3	22.5
	3H	21.3	21.9	21.6	22.2	22.7	21.3	21.9	21.7	22.3	22.7
	4H	21.1	21.7	21.6	22.1	22.6	21.2	21.7	21.6	22.2	22.7
	6H	21.1	21.6	21.6	22.0	22.3	21.1	21.7	21.6	22.0	22.4
	8H	21.0	21.5	21.5	21.9	22.3	21.0	21.6	21.6	21.9	22.3
	12H	21.0	21.4	21.5	21.8	22.3	21.0	21.4	21.5	21.8	22.3
8H	4H	21.0	21.6	21.5	21.9	22.3	21.1	21.6	21.6	21.9	22.3
	6H	21.0	21.3	21.5	21.8	22.3	21.0	21.4	21.5	21.8	22.4
	8H	21.0	21.2	21.5	21.8	22.4	21.0	21.3	21.5	21.8	22.4
	12H	20.9	21.1	21.5	21.6	22.2	20.9	21.2	21.5	21.7	22.3
12H	4H	21.0	21.4	21.5	21.8	22.3	21.0	21.4	21.5	21.8	22.3
	6H	21.0	21.2	21.5	21.8	22.4	21.0	21.3	21.5	21.8	22.4
	8H	20.9	21.1	21.5	21.6	22.2	20.9	21.2	21.5	21.7	22.3
<b>Variations with the observer position for the luminaire spacings, S:</b>											
S = 1.0H		4.5 / -6.7					4.5 / -6.7				
S = 1.5H		7.0 / -7.7					7.0 / -7.7				
S = 2.0H		9.0 / -8.7					9.0 / -8.7				

**Coefficients of Utilization**

Ceiling reflectance	80			70			50			30			10			0		
Wall reflectance	70	50	30	10	70	50	30	10	50	30	10	50	30	10	50	30	10	0
Floor reflectance	20	20	20	20	20	20	20	20	20	20	20	20	20	20	20	20	20	0
RCR		(RCR: Room Cavity Ratio)																
Room Values are expressed as percentage of Lumen delivered to the task surface																		
0	119	119	119	119	116	116	116	116	111	111	111	106	106	106	102	102	102	100
1	113	110	108	105	111	108	106	104	104	102	100	100	99	97	97	96	95	93
2	107	102	98	95	105	100	97	93	97	94	91	94	92	89	91	89	87	86
3	102	95	90	86	100	94	89	85	91	87	84	88	85	82	86	83	81	79
4	96	88	83	78	94	87	82	78	85	80	77	83	79	76	81	78	75	73
5	91	82	76	72	89	82	76	72	80	75	71	78	74	70	76	73	70	68
6	86	77	71	67	85	76	71	66	75	70	66	73	69	65	72	68	65	63
7	82	72	66	62	81	72	66	62	70	65	61	69	64	61	68	64	61	59
8	78	68	62	58	77	67	61	57	66	61	57	65	60	57	64	60	57	55
9	74	64	58	54	73	63	58	54	62	57	53	62	57	53	61	56	53	52
10	70	60	54	50	69	60	54	50	59	54	50	58	53	50	58	53	50	49

**NOTE:** An asymmetry correction has been applied to the beam distribution of this measurement in order to accurately calculate UGR.

