



Product Overview

Product Name / Code	MORGAN 12W Wall Light - LC4406
Description	Aluminium and Glass, IP65, White, 4000K
Manufacturer	Decrolux Lighting Pty Ltd



Laboratory and Equipment

System Name / Model	LabSpion / Freedom VIS (Custom Viso)
Manufacturer / Serial Number	Ibsen Photonics, Denmark / 2417457569
Sensor Name	LabSensor Model2
Sensor Serial Number / Calibration Date	3430823524 / 7/12/2022

Measurement Details

Test Date and Time	14/04/2023 2:33:50 PM
Operator	Roy Simpson
C-Planes Measured	36
Measurement Resolution	10°
Measurement Distance	442.5cm
Measurement Number	VFR-230414-0053-MS
Tracking Link	http://www.visosystems.com/tracking/?id=VT230417-000897



Performance

Total Lumen Output	833lm
Light Efficiency	66 Lumen/Watt
Peak (cd)	379cd
Nominal Power	12.7W
Input Voltage	240V
Frequency of Input Power	60Hz
Power Factor	0.96
Warm-up (stabilisation) Time	Lamp stabilized in 1 hour 0 min
Warm-up Variation	-3.6%

Spectral Power Distribution (SPD)

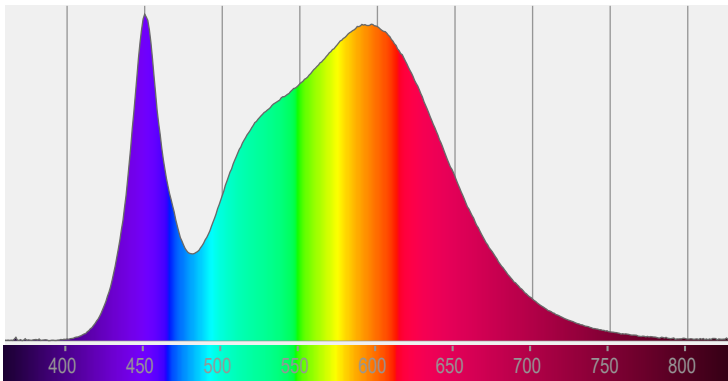

Input Power Curve

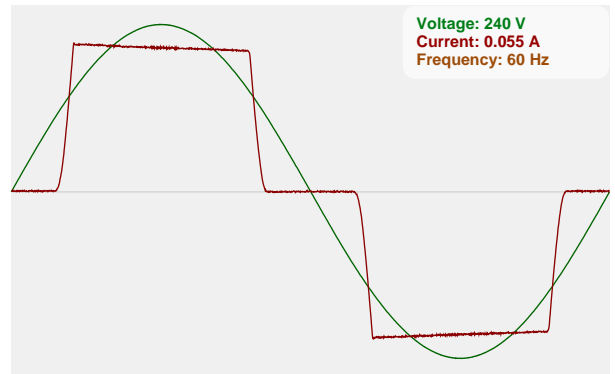

Optic Specifications

Correlated Colour Temperature, Target	4000K
Correlated Colour Temperature, Measured	4018K
Colour Rendering Index	CRI 82.6
R9 Value	R9 = 8.5
Colour Rendering TM30-18	R _f 84.0 - R _g 96.1
Colour Quality Scale	CQS = 82.1
Beam Angle	98.6°

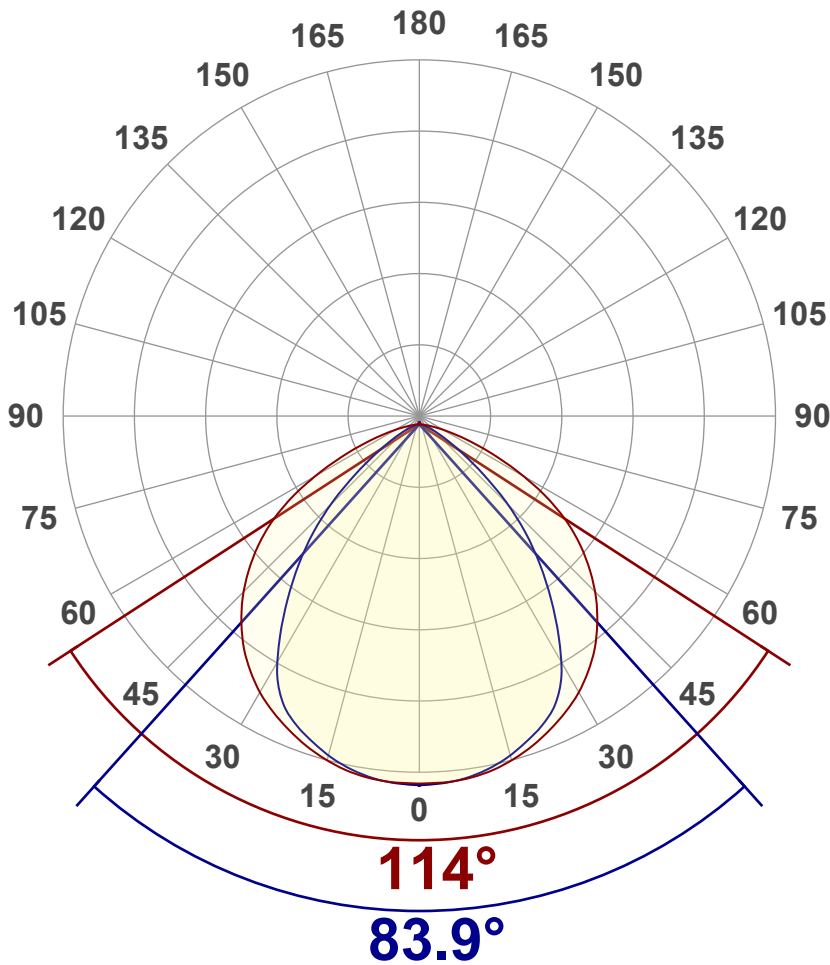

Angular Distribution – 0° / 90° Plane

Main Values

Total Lumen Output	833 lm
Lumen Up% / Down%	0.61 % / 99.39%
Peak Intensity	379 cd
Beam Angle (50%)	98.6°
Beam Angle (90%)	83.9°
Beam Angle (10%)	112.2°

Cut-off Angle

Average 2.5%	152.9°
---------------------	--------

Field Angle

Average 10%	134.2°
--------------------	--------

Intensity Ratio

In 120° Cone	90.6%
In 90° Cone	67.3%

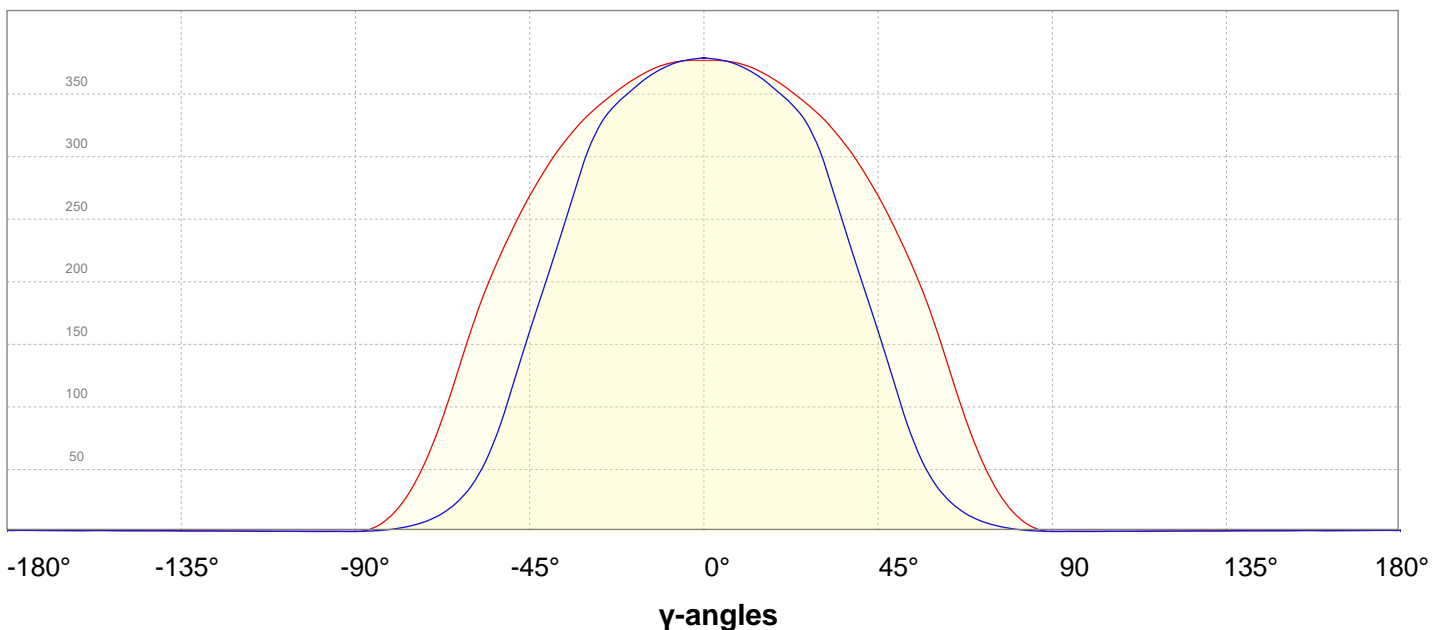
C000-C180
C090-C270
Linear Distribution Diagram – Intensity (candela) vs γ -angle

Beam Details

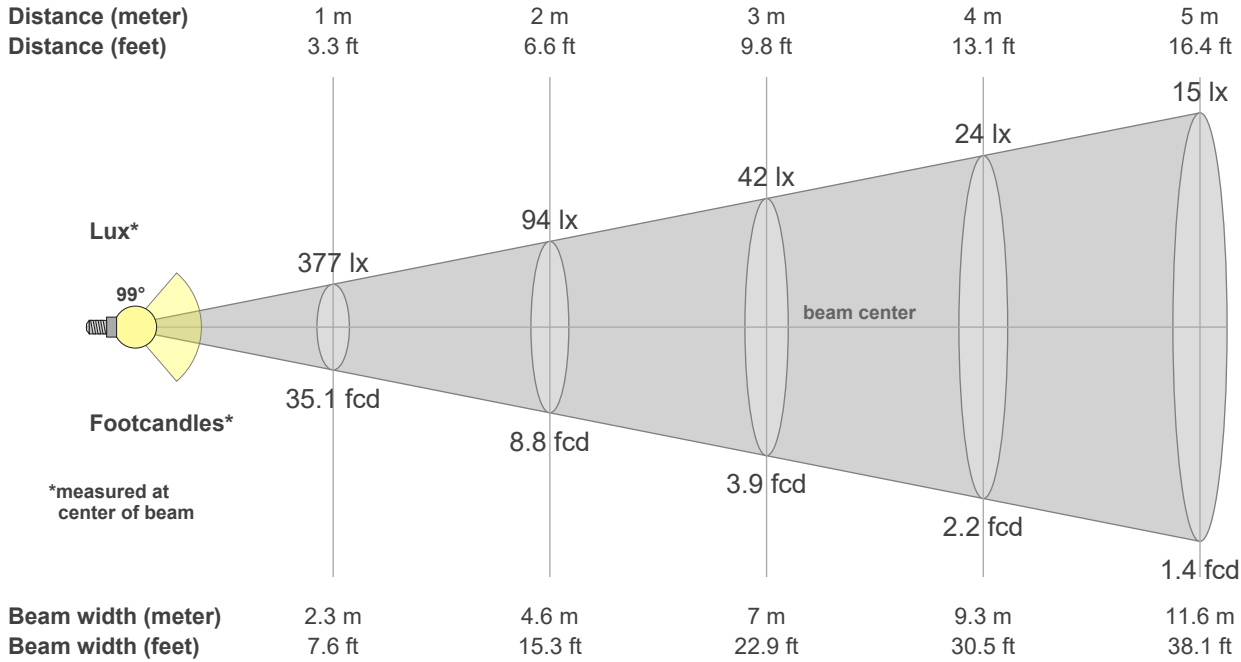

Beam intensities from 1 – 20m

1	2	3	4	5	6	7	8	9	10	11	12	13	14	15	16	17	18	19	20	m
3.3	6.6	9.8	13.1	16.4	19.7	23	26.2	29.5	32.8	36.1	39.4	42.7	45.9	49.2	52.5	55.8	59.1	62.3	65.6	ft
377	94	42	24	15	10	8	6	5	4	3	3	2	2	2	1	1	1	1	1	lux
35.1	8.8	3.9	2.2	1.4	1	0.7	0.5	0.4	0.4	0.3	0.2	0.2	0.2	0.2	0.1	0.1	0.1	0.1	0.1	fc

Intensities in 0° c-plane

0°	5°	10°	15°	20°	25°	30°	35°	40°	45°	50°	55°	60°	65°	70°	75°	80°	85°	90°	95°	γ
377	377	374	367	358	346	333	316	294	268	238	204	162	114	71	38	16	4	1	1	cd
100%	100%	99%	97%	95%	92%	88%	84%	78%	71%	63%	54%	43%	30%	19%	10%	4%	1%	0%	0%	of 0°val

Intensities in 90° c-plane

0°	5°	10°	15°	20°	25°	30°	35°	40°	45°	50°	55°	60°	65°	70°	75°	80°	85°	90°	95°	γ
377	377	371	362	349	333	304	256	208	160	111	67	37	21	11	6	3	1	1	1	cd
100%	100%	98%	96%	93%	88%	81%	68%	55%	43%	29%	18%	10%	6%	3%	1%	1%	0%	0%	0%	of 0°val

Intensities in 180° c-plane {INT_TABLE_180_START}

•	•	•	•	•	•	•	•	•	•	•	•	•	•	•	•	•	•	•	•	γ
																				cd
%	%	%	%	%	%	%	%	%	%	%	%	%	%	%	%	%	%	%	%	of 0°val

Intensities in 270° c-plane

0°	5°	10°	15°	20°	25°	30°	35°	40°	45°	50°	55°	60°	65°	70°	75°	80°	85°	90°	95°	γ
377	377	371	362	349	333	304	256	208	160	111	67	37	21	11	6	3	1	1	1	cd
100%	100%	98%	96%	93%	88%	81%	68%	55%	43%	29%	18%	10%	6%	3%	1%	1%	0%	0%	0%	Of 0°val



Colour Details

Correlated Colour Temperature, Target	CCT = 4000K
Correlated Colour Temperature, Measured	CCT = 4018K
Colour Rendering Index	CRI 82.6
Colour Rendering Index R9 Value	R9 = 8.5
Colour Rendering TM30-18	R _f 84.0, R _g 96.1
Colour Quality Scale	CQS = 82.1

MacAdam Steps	SDCM = 0.7
Colour Coordinates CIE 1931	(x;y) = (0.381;0.377)
Colour Coordinates CIEs 1960	(u;v) = (0.225; 0.334)
Colour Deviation from BBL	Duv = 0.0008
Colour Coordinate CIEs 1976 (CIELUV)	(u';v') = (0.225;0.502)

Colour Rendering Index per reference colour (CIE 1995)

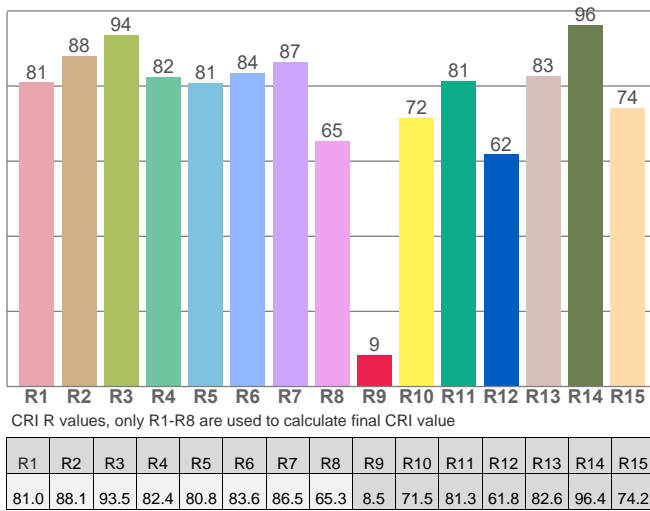

TM30-18 R_f-values per hue bin

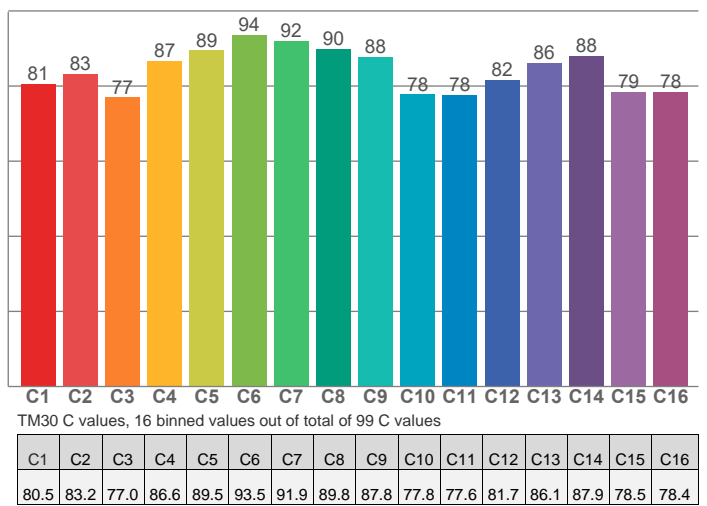

CIE 1931

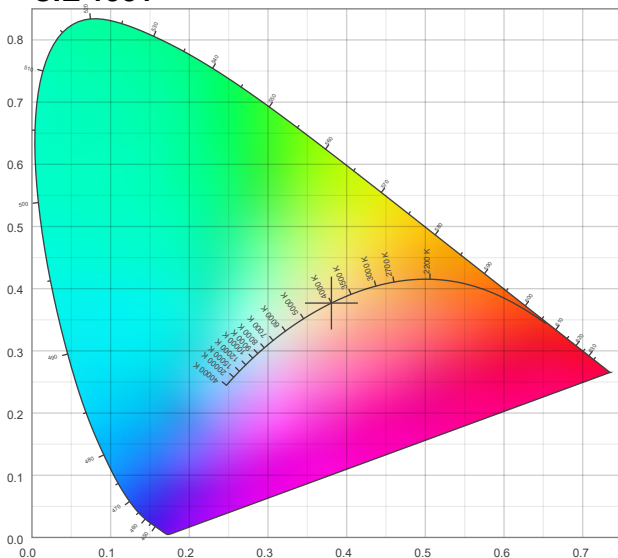

CIE 1931 – Zoomed

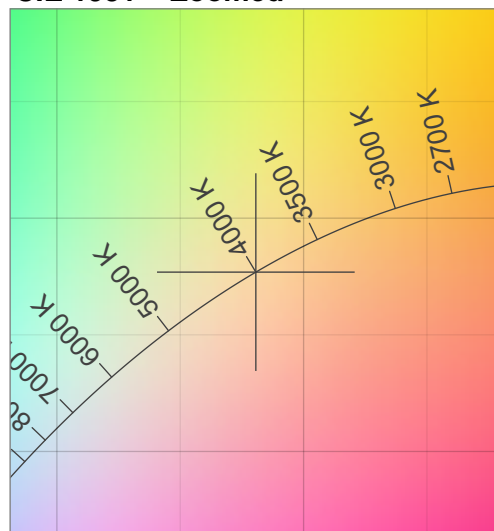

Iso-intensity Diagram (Iso-Candela)

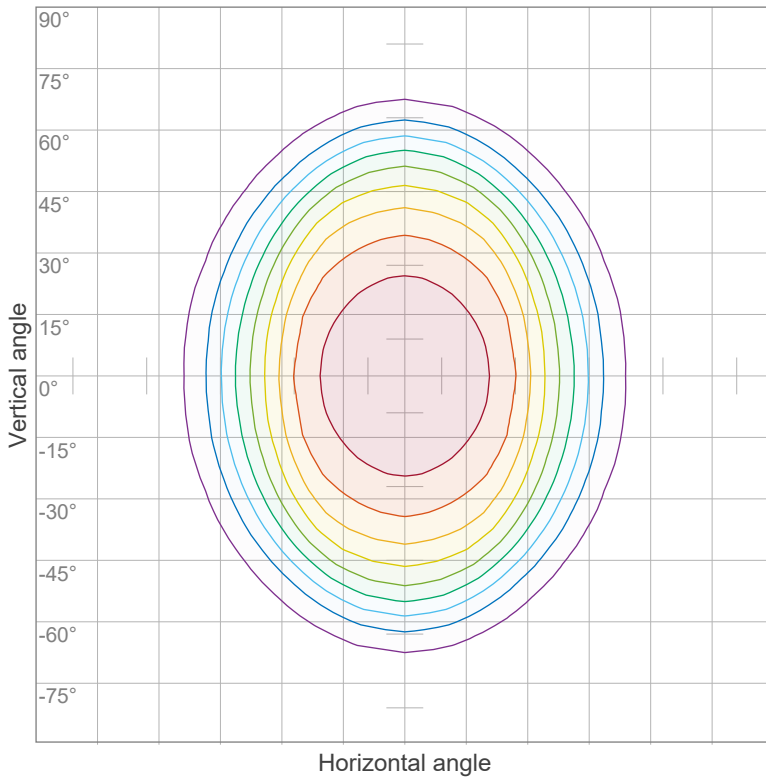

90 %	340.7 cd
80 %	302.8 cd
70 %	265.0 cd
60 %	227.1 cd
50 %	189.3 cd
40 %	151.4 cd
30 %	113.6 cd
20 %	75.7 cd
10 %	37.9 cd

Peak intensity: 378.6 cd
Number of c-planes: 36

Iso-illuminance Diagram (Iso-lux)

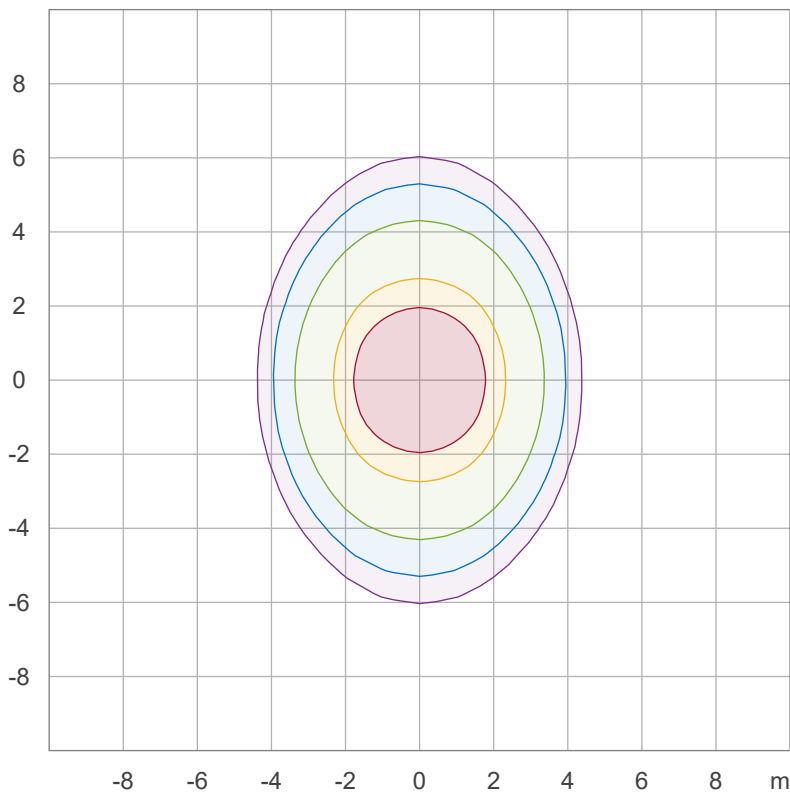

50.0 %	21.0 lx
30.0 %	12.6 lx
10.0 %	4.2 lx
5.0 %	2.1 lx
3.0 %	1.3 lx

Peak illuminance: 42.0 lx
Mounting height: 3.0 m
Number of c-planes: 36



Light Planning – UGR table

Uncorrected, comprehensive UGR table according to 117-1995

Reflectances		70	70	50	50	30	70	70	50	50	30
ρ Ceiling		70	70	50	50	30	70	70	50	50	30
ρ Walls		50	30	50	30	30	50	30	50	30	30
ρ Floor		20	20	20	20	20	20	20	20	20	20
Room size		Viewed Crosswise					Viewed Endwise				
H = mounting height above eye level											
X	Y	(Viewing direction orthogonal to lamp length axis)					(Viewing direction parallel to lamp length axis)				
2H	2H	25.2	26.2	25.4	26.5	26.7	20.2	21.2	20.4	21.5	21.7
	3H	25.9	27.0	26.3	27.3	27.5	20.1	21.1	20.5	21.4	21.6
	4H	26.1	27.1	26.5	27.4	27.7	20.0	21.0	20.4	21.3	21.6
	6H	26.3	27.1	26.6	27.4	27.8	20.0	20.9	20.3	21.2	21.6
	8H	26.2	27.1	26.6	27.4	27.8	20.0	20.8	20.3	21.1	21.5
	12H	26.2	27.0	26.6	27.4	27.8	19.9	20.7	20.3	21.1	21.5
4H	2H	25.0	26.0	25.4	26.3	26.6	20.6	21.6	21.0	21.9	22.1
	3H	25.9	26.8	26.3	27.1	27.6	20.6	21.4	21.0	21.8	22.2
	4H	26.1	26.8	26.5	27.3	27.8	20.5	21.3	20.9	21.7	22.2
	6H	26.2	26.9	26.7	27.3	27.6	20.4	21.2	20.9	21.5	21.9
	8H	26.2	26.8	26.7	27.2	27.6	20.4	21.1	20.9	21.4	21.8
	12H	26.1	26.7	26.6	27.1	27.6	20.3	20.9	20.8	21.3	21.8
8H	4H	26.0	26.7	26.5	27.0	27.4	20.5	21.2	21.0	21.5	21.9
	6H	26.1	26.6	26.6	27.0	27.6	20.5	20.9	21.0	21.4	22.0
	8H	26.1	26.5	26.6	27.1	27.7	20.4	20.9	21.0	21.4	22.0
	12H	26.1	26.4	26.7	27.0	27.6	20.4	20.7	21.0	21.3	21.9
12H	4H	25.9	26.5	26.4	26.9	27.4	20.4	21.0	21.0	21.4	21.9
	6H	26.1	26.5	26.6	27.0	27.7	20.5	20.9	21.0	21.4	22.0
	8H	26.1	26.4	26.7	26.9	27.5	20.4	20.8	21.0	21.3	21.9

Variations with the observer position for the luminaire spacings, S:

S = 1.0H	0.2 / -0.3	0.9 / -2.2
S = 1.5H	1.1 / -1.8	2.0 / -5.2
S = 2.0H	2.4 / -3.9	3.3 / -7.6

Coefficients of Utilization

Ceiling reflectance	80	70	50	30	10	0												
Wall reflectance	70	50	30	10	70	50	30	10	50	30	10	50	30	10	0			
Floor reflectance	20	20	20	20	20	20	20	20	20	20	20	20	20	20	0			
RCR (RCR: Room Cavity Ratio)																		
Room Values are expressed as percentage of Lumen delivered to the task surface																		
0	119	119	119	119	116	116	116	116	111	111	111	106	106	106	101	101	101	99
1	111	107	103	100	108	105	101	99	100	98	95	96	94	92	93	91	90	88
2	102	95	90	85	100	94	88	84	90	86	82	87	83	80	84	81	78	76
3	94	85	78	73	92	84	77	72	81	75	71	78	73	69	76	72	68	66
4	87	77	69	63	85	75	68	62	73	67	62	70	65	61	68	64	60	58
5	81	69	61	55	79	68	60	55	66	59	54	64	58	54	62	57	53	51
6	75	63	55	49	73	62	54	48	60	53	48	58	52	48	57	51	47	45
7	70	57	49	43	68	56	49	43	55	48	43	53	47	43	52	47	42	40
8	65	52	44	39	63	52	44	39	50	44	39	49	43	38	48	42	38	36
9	61	48	41	35	59	48	40	35	46	40	35	45	39	35	44	39	35	33
10	57	45	37	32	56	44	37	32	43	37	32	42	36	32	41	36	32	30



Flicker Details

Flicker Meter Type	Viso Systems LabFlicker
Frequency of Input Power	60Hz
Flicker/TLA Sample Rate	40000 sample/s
Measurement Time	
PstLM	180 sec
All other indices	1.2 sec

Flicker Indices (IES)	
Flicker Percentage	100%
Flicker Frequency	239.52Hz
Flicker Index	0.33
Flicker SVM Value	2.09
Flicker PstLM Value	0

Flicker Frame

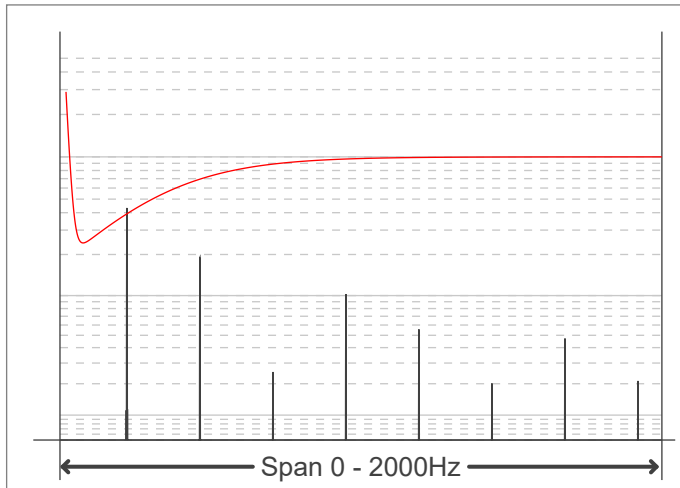

Flicker FFT (flicker curve in frequency domain)

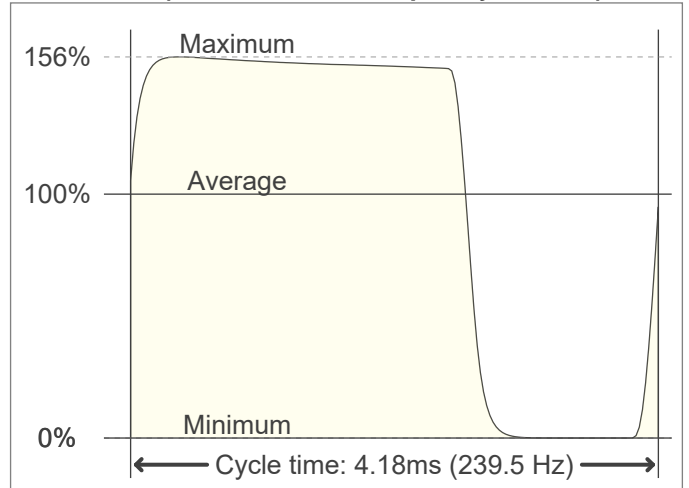

IEEE 1789 Frequency/Modulation Plot

