

# TECHLUME

A U S T R A L I A

## LM-79 Test Report

Testing Method:	IES Approved Method: Electrical and Photometric Measurements of Solid-State Lighting Products
Relevant Standards:	IES LM-79-08
Test Date and Time:	16/10/2023 11:36:11 AM
Test Location:	Techlume Australia - East Goderich Street Deloraine, TAS 7304
Operator:	Johnny Elmer
Measurement Number:	VFR-231016-0222-MS
Measurement Method:	Far Field, Type C Horizontal
Measurement Distance:	450.7 cm

### Equipment Used

System Name:	LabSpion Goniometer
Sensor Name / Model:	Viso LabSensor Model2 / Freedom VIS (Custom Viso)
Spectrometer Range:	360 nm – 830 nm
Calibration Date:	7/12/2022
Flicker Meter Type:	Viso Systems LabFlicker
Manufacturer:	Viso Systems, Denmark

### Test Conditions

Ambient Temperature:	25 °C ± 1 °C
----------------------	--------------

### Remarks

The results stated in this report represent the tested sample only. All photometric and colourimetric data has been measured in compliance with IES LM-79-08 standards.



**Product Overview**

Product Description: JARDAN 60W Aisle Track Light, 580x190mm, 3000K, CRI90, Non-Dim

Item Number: LC7720

Manufacturer: Decrolux Lighting Pty Ltd

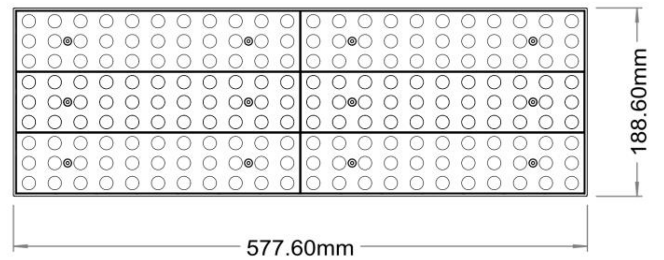

**Photometric Measurements**

Total Luminous Flux	Luminous Efficacy	Luminous Intensity
7283 lm	124 Lumen/watt	4943 cd

Correlated Colour Temperature, Target	Correlated Colour Temperature, Measured	Colour Rendering Index (CRI)
3000 K	2934 K	Ra 92.8

**Electrical Measurements**

Input Voltage	Input Current	Input Power	Input Voltage Frequency
240 VAC	0.251 A	58.8 W	60 Hz

Power Factor	Stabilisation Time	Stabilisation Variation	Hours Operated Prior to Test
0.97	Lamp stabilized in 39 min 27 sec	-2.9%	0 hours



### Spectral Power Distribution (SPD)

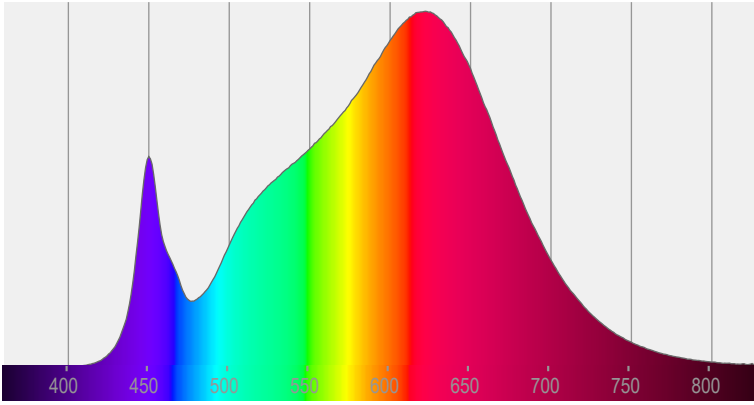

### Input Power Curve

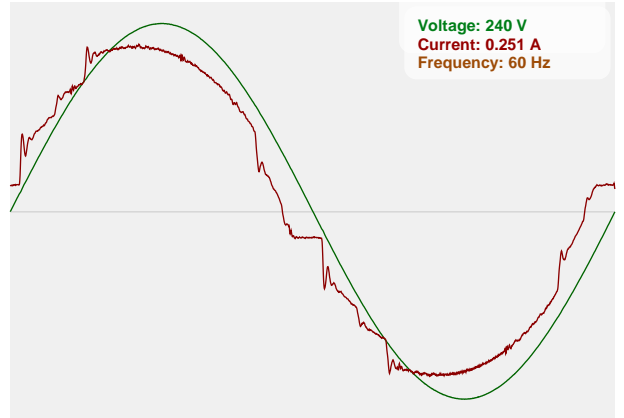

### Flicker Details

Flicker Sample Rate	Flicker Percentage	Flicker Frequency	Flicker Index
20000 sample/s	1.97%	120.48 Hz	0

Flicker SVM Value	Flicker PstLM Value	Measurement Time (PstLM)	Measurement Time (all other indices)
0.04	0.02	180 s	1.2 s

### IEEE 1789 Frequency/Modulation Plot

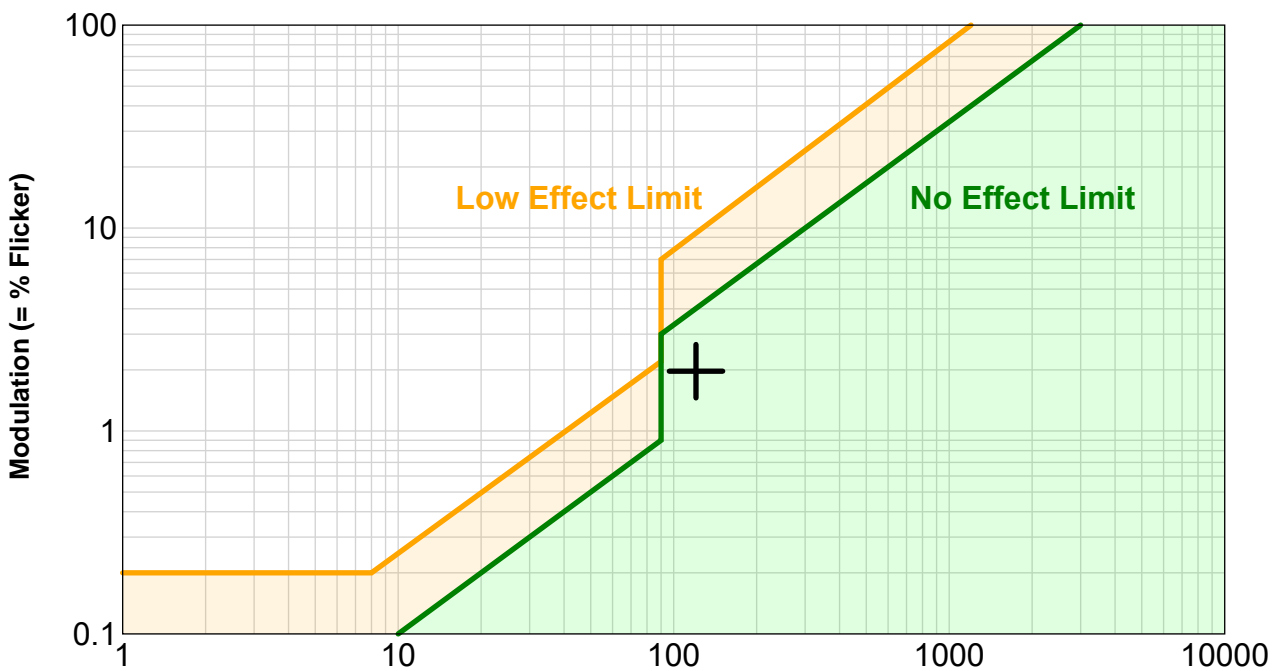

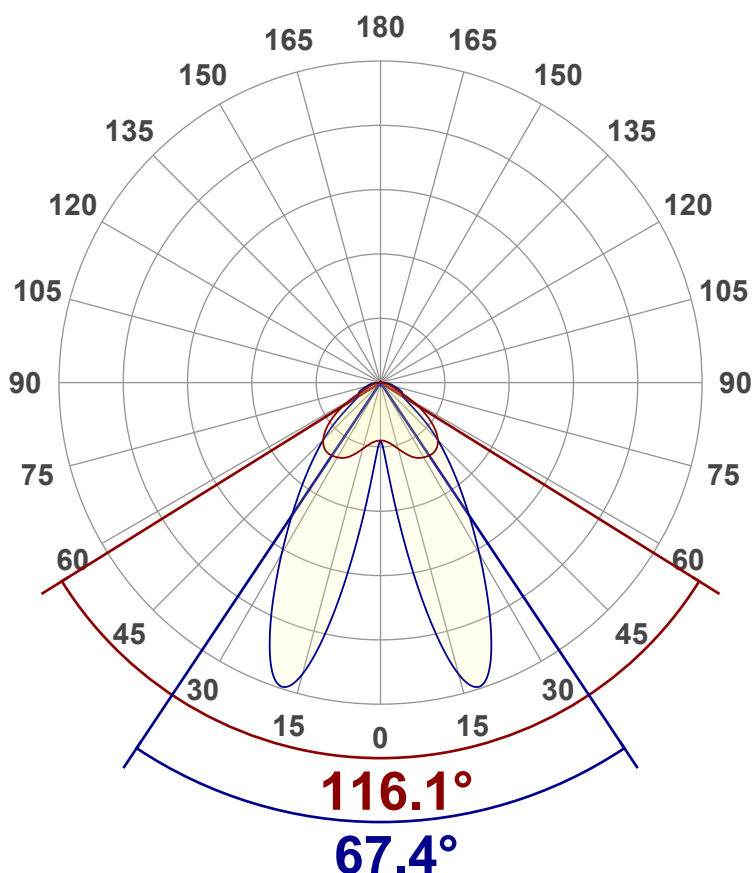
**Angular Distribution – 0° / 90° Plane**

**Main Values**

<b>Total Lumen Output</b>	7283 lm
<b>Lumen Up%</b>	0.23%
<b>Lumen Down%</b>	99.77%
<b>Peak Intensity</b>	4943 cd
<b>Beam Angle (90%)</b>	67.4°

**Cut-off Angle**

<b>Average 2.5%</b>	157.8°
---------------------	--------

**Field Angle**

<b>Average 10%</b>	121.8°
--------------------	--------

**Intensity Ratio**

<b>In 120° Cone</b>	92.5%
<b>In 90° Cone</b>	69.4%

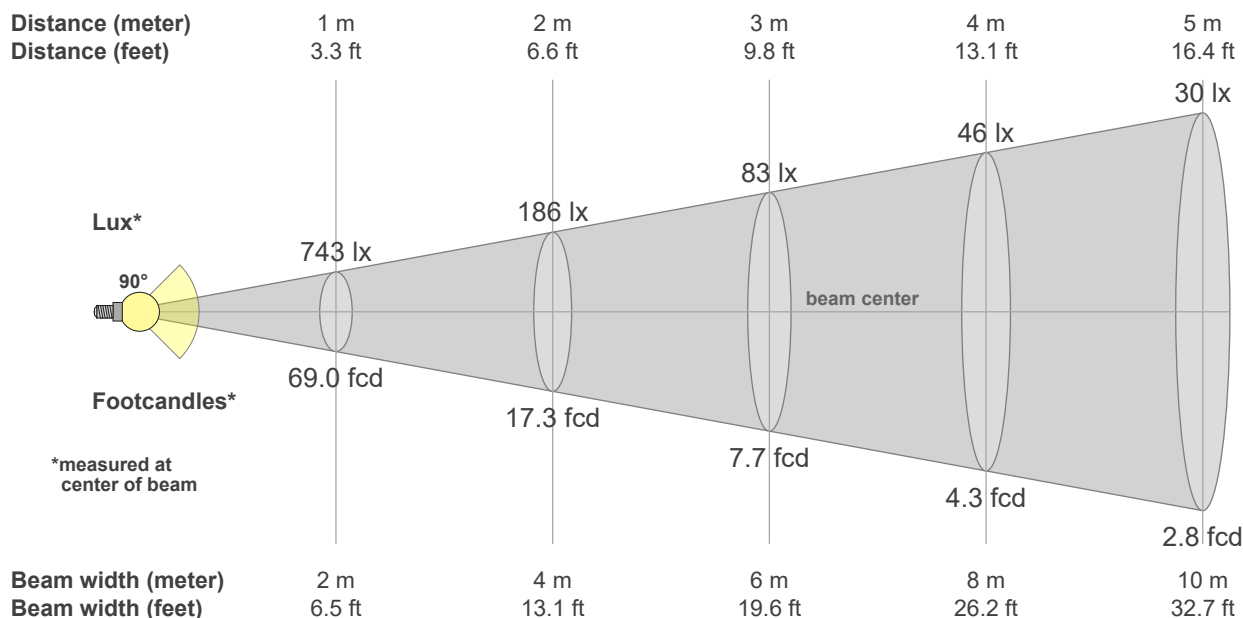
**C000-C180**
**C090-C270**

**Beam intensities from 1 – 20m**

1	2	3	4	5	6	7	8	9	10	11	12	13	14	15	16	17	18	19	20	m
3.3	6.6	9.8	13.1	16.4	19.7	23	26.2	29.5	32.8	36.1	39.4	42.7	45.9	49.2	52.5	55.8	59.1	62.3	65.6	ft
743	186	83	46	30	21	15	12	9	7	6	5	4	4	3	3	3	2	2	2	lux
69	17.3	7.7	4.3	2.8	1.9	1.4	1.1	0.9	0.7	0.6	0.5	0.4	0.4	0.3	0.3	0.2	0.2	0.2	0.2	fc



### Colour Details

Colour Rendering Index (CRI)	Colour Rendering Index R9 Value	Colour Rendering TM30-18
Ra 92.8	R9 = 60.5	R <sub>f</sub> 90.9, R <sub>g</sub> 101.4

Colour Quality Scale	Correlated Colour Temperature, Target	Correlated Colour Temperature, Measured
CQS = 89.7	CCT = 3000 K	CCT = 2934 K

MacAdam Steps	Colour Coordinates CIE 1931	Colour Deviation from BBL
SDCM = 3.0	(x;y) = (0.437;0.404)	Duv = -0.0025

### Colour Rendering Index per reference colour (CIE 1995)

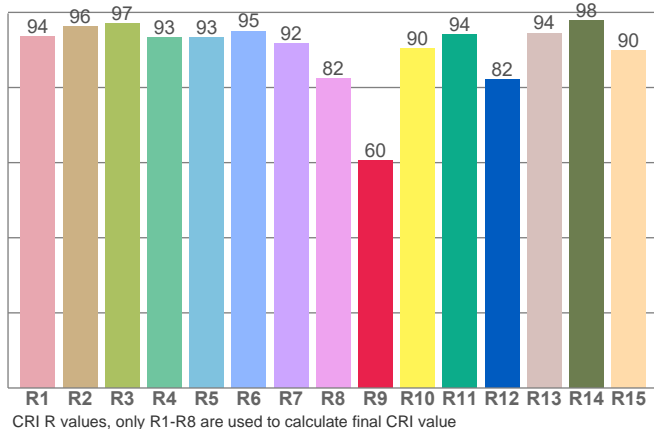

R1	R2	R3	R4	R5	R6	R7	R8	R9	R10	R11	R12	R13	R14	R15
93.6	96.3	97.1	93.2	93.3	95.0	91.6	82.3	60.5	90.3	94.1	82.2	94.4	97.7	89.8

### TM30-18 R<sub>f</sub>-values per hue bin

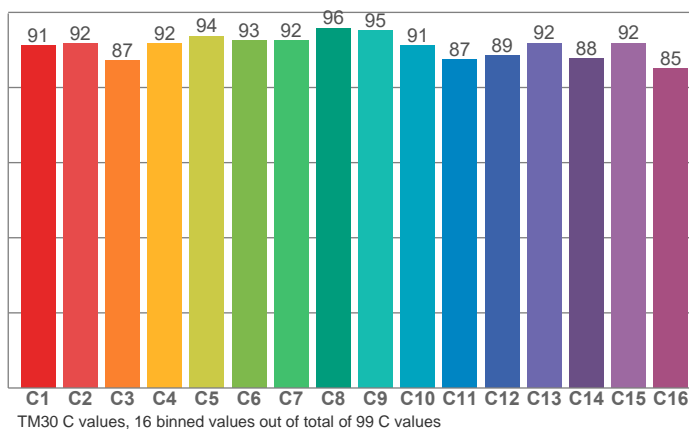

C1	C2	C3	C4	C5	C6	C7	C8	C9	C10	C11	C12	C13	C14	C15	C16
91.2	91.6	87.1	91.7	93.6	92.5	92.4	95.8	95.1	91.1	87.5	88.5	91.8	87.7	91.8	85.0

### CIE 1931

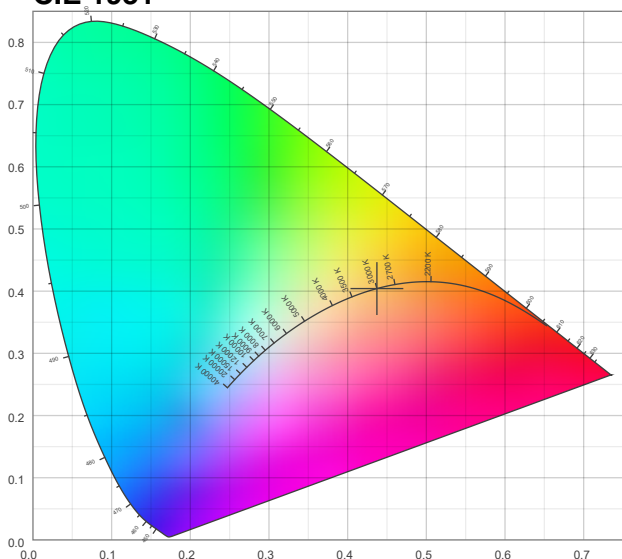

### CIE 1931 – Zoomed

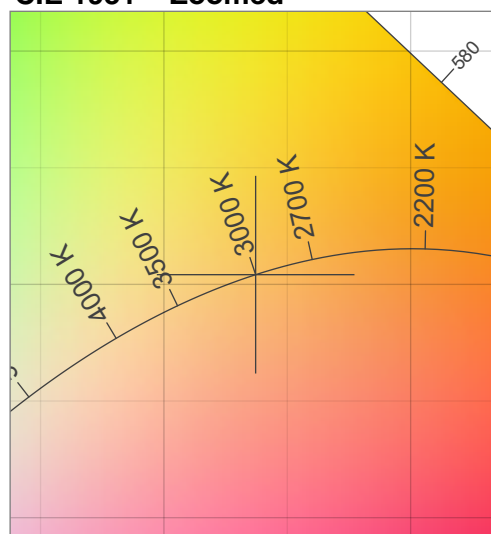

### Iso-intensity Diagram (Iso-Candela)

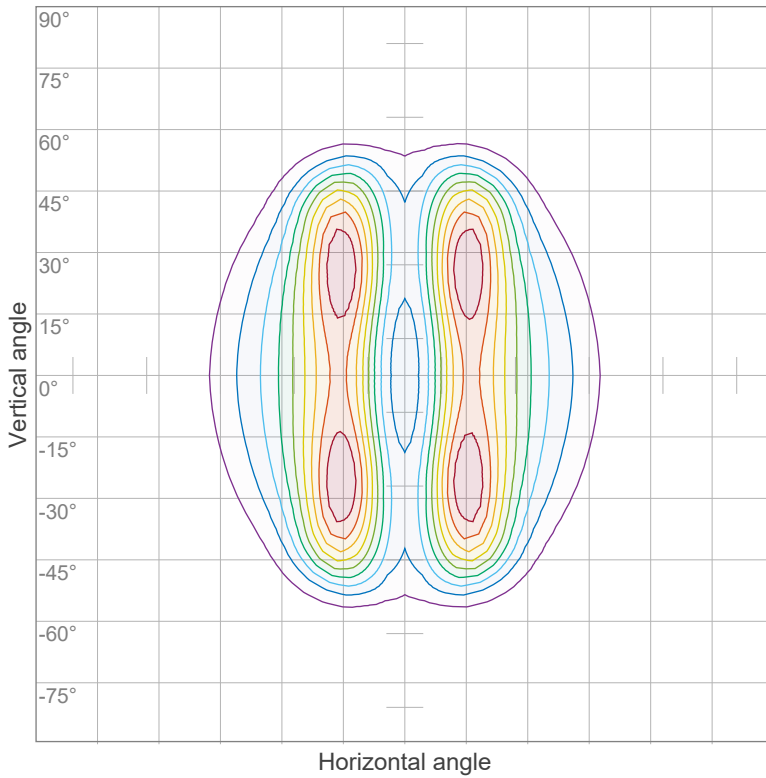

90 %	4448.9 cd
80 %	3954.5 cd
70 %	3460.2 cd
60 %	2965.9 cd
50 %	2471.6 cd
40 %	1977.3 cd
30 %	1483.0 cd
20 %	988.6 cd
10 %	494.3 cd

Peak intensity: 4943.2 cd  
Number of c-planes: 72

### Iso-illuminance Diagram (Iso-lux)

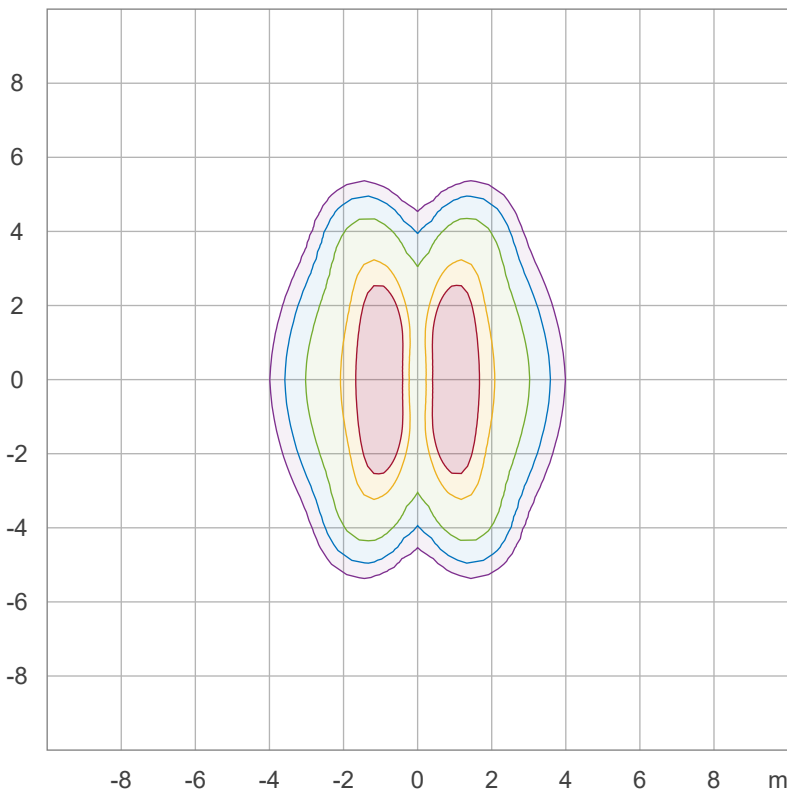

50.0 %	197.0 lx
30.0 %	118.2 lx
10.0 %	39.4 lx
5.0 %	19.7 lx
3.0 %	11.8 lx

Peak illuminance: 393.9 lx  
Mounting height: 3.0 m  
Number of c-planes: 72



**Light Planning – UGR table**

*Uncorrected, comprehensive UGR table according to 117-1995*

Reflectances		70	70	50	50	30	70	70	50	50	30
ρ Ceiling		70	70	50	50	30	70	70	50	50	30
ρ Walls		50	30	50	30	30	50	30	50	30	30
ρ Floor		20	20	20	20	20	20	20	20	20	20
Room size		Viewed Crosswise					Viewed Endwise				
H = mounting height above eye level		(Viewing direction orthogonal to lamp length axis)					(Viewing direction parallel to lamp length axis)				
X	Y										
2H	2H	24.9	25.9	25.1	26.2	26.4	18.3	19.3	18.5	19.6	19.8
	3H	24.8	25.9	25.2	26.1	26.3	18.5	19.6	18.9	19.9	20.1
	4H	24.7	25.8	25.1	26.0	26.3	18.8	19.8	19.2	20.1	20.3
	6H	24.8	25.7	25.1	26.0	26.3	19.1	20.0	19.5	20.3	20.7
	8H	24.7	25.6	25.1	25.9	26.3	19.3	20.1	19.6	20.5	20.9
	12H	24.7	25.5	25.1	25.9	26.3	19.4	20.2	19.7	20.6	21.0
4H	2H	24.6	25.7	25.0	25.9	26.2	18.9	19.9	19.3	20.2	20.5
	3H	24.7	25.5	25.1	25.9	26.3	19.3	20.2	19.7	20.5	21.0
	4H	24.6	25.4	25.1	25.8	26.4	19.5	20.3	20.0	20.7	21.3
	6H	24.6	25.4	25.1	25.7	26.1	19.9	20.6	20.4	21.0	21.4
	8H	24.6	25.3	25.1	25.7	26.0	20.1	20.7	20.6	21.1	21.5
	12H	24.6	25.1	25.1	25.6	26.0	20.2	20.8	20.7	21.2	21.6
8H	4H	24.5	25.2	25.1	25.6	26.0	19.6	20.3	20.1	20.6	21.0
	6H	24.6	25.1	25.1	25.5	26.1	20.0	20.5	20.5	21.0	21.5
	8H	24.6	25.0	25.1	25.6	26.2	20.3	20.7	20.8	21.2	21.9
	12H	24.6	25.0	25.2	25.5	26.1	20.5	20.8	21.1	21.3	21.9
12H	4H	24.5	25.1	25.0	25.5	26.0	19.6	20.1	20.1	20.6	21.0
	6H	24.6	25.0	25.1	25.5	26.2	20.1	20.5	20.6	21.0	21.6
	8H	24.6	24.9	25.2	25.4	26.1	20.3	20.6	20.9	21.1	21.8
<b>Variations with the observer position for the luminaire spacings, S:</b>											
S = 1.0H		2.0 / -3.2					1.4 / -1.6				
S = 1.5H		3.5 / -5.5					2.5 / -2.1				
S = 2.0H		5.3 / -7.1					3.3 / -2.5				

**Coefficients of Utilization**

Ceiling reflectance	80			70			50			30			10			0		
Wall reflectance	70	50	30	10	70	50	30	10	50	30	10	50	30	10	50	30	10	0
Floor reflectance	20	20	20	20	20	20	20	20	20	20	20	20	20	20	20	20	20	0
RCR		(RCR: Room Cavity Ratio)										Room Values are expressed as percentage of Lumen delivered to the task surface						
0	119	119	119	119	116	116	116	116	111	111	111	106	106	106	102	102	102	100
1	111	107	103	100	108	105	101	99	100	98	95	97	94	92	93	91	90	88
2	102	95	90	85	100	94	88	84	90	86	82	87	83	80	84	81	78	76
3	94	85	78	72	92	84	77	72	81	75	71	78	73	69	76	72	68	66
4	87	76	69	63	85	75	68	62	73	66	61	70	65	61	68	64	60	58
5	80	69	61	55	78	68	60	54	66	59	54	64	58	53	62	57	53	51
6	74	62	54	48	73	61	53	48	59	52	47	58	52	47	56	51	46	45
7	69	56	48	42	67	56	48	42	54	47	42	53	46	42	51	46	41	39
8	64	51	43	38	63	51	43	38	49	42	37	48	42	37	47	41	37	35
9	60	47	39	34	58	46	39	34	45	38	34	44	38	33	43	37	33	31
10	56	43	36	30	55	43	35	30	42	35	30	41	34	30	40	34	30	28

**NOTE:** An asymmetry correction has been applied to the beam distribution of this measurement in order to accurately calculate UGR.

